

# STRUCTURAL BUILDING **COMPONENTS**<sup>TM</sup>

THE FUTURE OF FRAMING

May 2015

[www.sbcmag.info](http://www.sbcmag.info)

## Taking Trusses to New Heights

*Inside this Issue:* Moment Resistance • Sales Training & much more!

PRRST STD  
U.S. Postage  
**PAID**  
Madison, WI  
Permit No. 2223

SBC Magazine • 6300 Enterprise Lane • Suite 200 • Madison, WI 53719

*Framing the*  
**AMERICAN  
DREAM**<sup>®</sup>

A man with short dark hair, wearing a grey t-shirt, is seated at a wooden desk in an office. He is looking at two computer monitors. The left monitor displays a 3D architectural model of a building with a complex roof structure. The right monitor displays a software interface with a yellow truss structure and a table of data. The man's hands are on a black keyboard and mouse. In the foreground, there is a blue graphic overlay with white text. The background shows a window with horizontal blinds.

# TAKE YOUR DESIGN TEAM TO THE NEXT LEVEL.

Enroll your designers in MiTek University – our free online learning platform for every skill level. From your newest designers to your most experienced, these self-paced tutorials give them and your company a valuable edge when working in SAPHIRE™ software. Choose from a rich curriculum of courses including **Component Design – Panel 101**, our latest addition to the training library.

Increase your competitive advantage and improve your bottom line by enrolling at [mitek-us.com/miteku](http://mitek-us.com/miteku).

**MiTek**®  
Better Technology. Better Building.™

**Publisher**

Truss Publications, Inc.  
6300 Enterprise Lane • Suite 200  
Madison, WI 53719  
Phone: 608-310-6706 • Fax: 608-271-7006  
trusspubs@sbcmag.info • www.sbcmag.info

**Editor**

Rick Parrino  
Plum Building Systems • editor@sbcmag.info

**Managing Editor**

Sean Shields  
608-310-6728 • sshields@sbcmag.info

**Art Director**

Melinda Caldwell  
608-310-6729 • mcaldwell@sbcmag.info

**Editorial Review**

Kirk Grundahl  
608-274-2345 • kgrundahl@sbcmag.info

Suzi Grundahl

608-310-6710 • sgrundahl@sbcmag.info

**Advertising Sales & Marketing**

Melinda Caldwell  
608-310-6729 • mcaldwell@sbcmag.info

Sean Shields

608-310-6728 • sshields@sbcmag.info

**Staff Writers for May**

Emily Patterson • Matt Tanger

**Accountant**

Mike Younglove  
608-310-6714 • myounglove@sbcmag.info

**Computer Systems Administrator**

Jay Edgar  
608-310-6712 • jedgar@sbcmag.info

**Send all ad materials, insertion orders, contracts & payments to:**

Truss Publications, Inc.  
6300 Enterprise Lane • Suite 200  
Madison, WI 53719  
Phone: 608-310-6706 • Fax: 608-271-7006  
trusspubs@sbcmag.info • www.sbcmag.info

## contents

**Page 12**

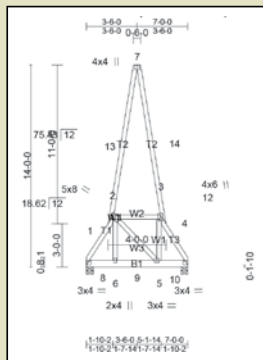

**on the cover:**

## Taking Trusses to New Heights

by Emily Patterson

**Page 18**

# MOMENT

**Why Bigger Plates Are a Good Thing**

## resistance

by Dave Brakeman, P.E., S.E. & Sean D. Shields

**Page 24**

# TOP 10 Employee Training Tools

## Sales Training

by Ben Hershey & Sean D. Shields

Editor's Message	5
Framer Viewpoint	8
Parting Shots	26

The mission of *Structural Building Components Magazine* (SBC) is to increase the knowledge of and to promote the common interests of those engaged in manufacturing and distributing structural building components. Further, SBC strives to ensure growth, continuity and increased professionalism in our industry, and to be the information conduit by staying abreast of leading-edge issues. SBC's editorial focus is geared toward the entire structural building component industry, which includes the membership of the Structural Building Components Association (SBCA). The opinions expressed in SBC are those of the authors and those quoted, and are not necessarily the opinions of Truss Publications or SBCA.

# A-to-Z

## the Eagle Metal advantage: every management solution, under one [ build it true every day<sup>SM</sup> ] roof

Manage your business your way by utilizing our comprehensive suite of products, services and solutions. It's a strategic decision to make your production more efficient and your plant more profitable in the future.

This end-to-end approach simplifies your efforts and reduces your costs. So we're able to bring your organization's profitability to life with maximum results.

It's everything you need, in one place making the combination of the whole a complete integration that gives you the most bang for your buck.

Call us today for a free demo and how to put Eagle Metal's solution suite to work for your business, your way.

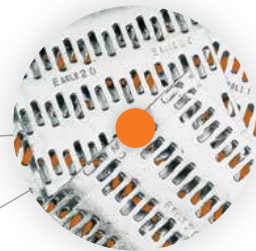
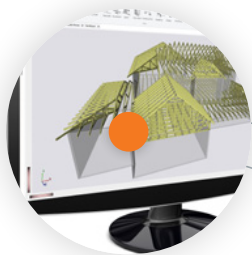

CONNECTOR PLATES | ENGINEERING | DESIGN SOFTWARE | SUPPORT | EQUIPMENT

EagleMetal.com | 800-521-3245 | 12300 Ford Road, Suite 110, Dallas, Texas 75234



# editor's message

by Rick Parrino

## We Need You! Share Your Marketplace Challenges

**The Joint Industry Testing Subcommittee needs your perspective on the test plans developed for upcoming testing in SBCRI and to generate future testing concepts.**

**W**hen the SBC Research Institute (SBCRI) was built in 2007, I remember our discussions on the Board about the ways in which this state-of-the-art structural testing facility would give our industry significantly greater understanding about the three-dimensional performance of buildings. More than anyone else could! We'd have the ability to finally look at the "systems effects" that exist in real buildings, begin to quantify this information, and eventually gain the benefit of that knowledge by incorporating it into how we design our products.

Everything we do as component manufacturers (CMs) focuses on designing and building products that will do their part to withstand all of the loads they intended to bear and to create the load path intended by the building designer, from the point they originate down into the foundation. As we gain a deeper understanding of how loads actually flow through an entire building's structural system, we can figure out how to take advantage of it and create value for ourselves and our customers. Every test conducted at SBCRI helps us learn more about structural performance.

There's a lot of opportunity out there, so the big questions are: where should SBCRI focus its efforts, and what questions do we try to solve? The answers to those questions rely mostly on you. Up until recently, most of the industry testing conducted at SBCRI was limited by external factors. When the housing industry crashed starting in 2007, funding for industry testing dried up very quickly. SBCRI remained financially viable and operational by becoming a proprietary research and development (R&D) facility, conducting private testing for companies seeking to create new structural framing products, materials and construction methods.

Through proprietary testing, SBCRI acquired a deeper understanding of testing techniques and approaches, and further refined how to more accurately apply loads and measure load path. None of the actual information collected from the proprietary testing was ever used or shared with anyone but the client. However, as we all have learned, practice and experience make us all better at what we do.

While proprietary testing made up a majority of SBCRI's testing calendar, it's important to point out that industry-specific testing continued to occur. (*SBC Magazine* has already covered many of these tests: top chord bearing, lumber design values, wood structural panel shear walls, seismic design coefficients, etc.). Over the coming months, we will share the results of other tests, including those described in the sidebar on page 7.

By 2014, the housing industry had recovered enough making it possible to resume funding on the important activity of industry testing. Since 2007, SBCA and the Truss Plate Institute (TPI) have kept a prioritized list of industry tests to perform. The intent of putting together that list is to define and explore challenges CMs regularly experience in the marketplace and devise testing plans to gather empirical data to address those challenges.

### So where do you come in?

All SBCA CM members are encouraged to think about the framing challenges in their markets and share them with SBCA staff. Testing concepts can then be

### at a glance

- A series of test concepts have been suggested. SBCA needs your input on these concepts to ensure the industry testing conducted in SBCRI helps improve market opportunities for CMs.
- The goal of industry testing in SBCRI is to tackle the daily design and framing challenges CMs see, and find solutions that make components even more reliable and cost effective.
- SBCRI was developed and built specifically for this purpose.

Continued on page 6

## Editor's Message

Continued from page 5

developed around those challenges to try to either address a problem or create an opportunity for CMs to reduce their costs or sell more products. To more fully understand how the test concept process works, SBCA has developed a flowchart (see page 7). A good explanation of how the flowchart really works can be found in the online edition of this article.

In 2015, there are multiple opportunities within SBCRI for industry testing. The great part is that each of these tests will yield real data that should benefit CMs through better understanding of load capacities and load paths, more efficient design procedures, or easier installation methods. The sidebar on page 7 lists summaries of three testing concepts currently under review. On March 19, SBCA's Board reviewed these test concepts during its meeting in Denver, CO. However, SBCA continues to seek testing input from all its membership.

SBCRI was built to benefit all TPI and SBCA members, as well as those who supply goods and services to our industry. As SBCRI helps our manufacturing businesses grow, our entire supply chain will benefit. SBCRI is an extremely valuable tool our industry can use to help us create even more efficient component framing solutions for our customers. In the end, the testing at SBCRI makes the products you produce better than all the alternatives, leading to greater market share for you.

In the eight years since SBCRI opened its doors, most of us have been testing our survival skills in the market rather than testing structures in the lab. Those survival skills prompted our industry to change even more rapidly, with technology, ingenuity and just plain desperation, leading us to make advancements we probably wouldn't have otherwise made. Those changes created additional opportunities for components to gain market advantage. So I encourage you to think about this for a few minutes, and if you ever had one of those, "I wonder if this would work" ideas, send them to us and we will submit it to the committee.

Let's get back to the fun stuff we built this association on and brush off the dust of gridlock brought on by difficult times. I personally have never been more excited about this industry and SBCA than when I think about the opportunities we have coming up this year for gathering important information to grow our markets. **SBC**



**SBCA**  
**Open Quarterly Meetings**

Madison Nashville Milwaukee

Mark your calendar with this year's meeting schedule:

**May 12-13: Madison, WI**  
(includes Masters Competition)

**July 21-22: Nashville, TN**

**October 23: Milwaukee, WI**

Visit [sbcindustry.com/open-quarterly-meetings](http://sbcindustry.com/open-quarterly-meetings) for more details and to register.



## SBCA Board of Directors

### Officers & Executive Committee Reps.

- **President: Richard P. Parrino**  
Plum Building Systems, LLC • 515-978-6260
- **President-Elect/Treasurer: Jess Lohse** • Rocky Mountain Truss Co.  
406-265-5140
- **Secretary: Jack Dermer** • American Truss Systems, Inc.  
281-442-4584
- **Past President: Scott Ward** • Southern Components, Inc.  
318-687-3330 x106
- **Kenneth M. Cloyd** • California TrusFrame  
951-657-7491
- **Barry Dixon** • True House, Inc.  
904-757-7500
- **Dwight Hikel** • Shelter Systems Limited  
410-876-3900
- **Joseph D. Hikel** • Shelter Systems Limited  
410-876-3900

### At-Large Representatives

- **Gene Frogale** • Allied Systems • 540-665-9600
- **Greg Griggs** • ProBuild Southeast • 770-428-2604
- **Don Groom** • Panel Truss Texas, Inc. • 903-657-7000
- **Eric James** • Hart Components • 210-337-6464
- **Steve Stroder** • Timberland Lumber Company • 812-446-2397

### Directors Representing Chapters

- **Keith Azlin** • U.S. Components, LLC • 520-882-3709
- **Michael Balliet** • Builders FirstSource/Bama Truss & Components • 205-669-4188
- **Jimmy Broach** • Atlantic Building Components & Services, Inc. • 843-565-3999
- **James C. Finkenhoefer** • Truss Systems, Inc. • 770-787-8715
- **Taft Ketchum** • PDJ Components, Inc. • 845-469-9191
- **David Motter, P.E.** • Louws Truss, Inc. • 360-384-9000
- **David A. Raasch** • Lloyd Truss Systems • 507-387-4250
- **Michael L. Ruede** • A-1 Roof Trusses • 772-409-1010
- **Steven Spradlin** • Capital Structures, Inc. • 479-783-8666
- **Javan Yoder** • Stark Truss Company, Inc. • 330-478-2100 x2223

### Associate Member Directors

- **Scott Ballantyne** • Interfor • 360-788-2200
- **David B. Brakeman, P.E.** • Alpine • 314-344-9121
- **George Hull** • Hull Associates, LLC • 817-640-6240
- **Brent Kreutzer** • FastenMaster • 817-640-6240

# SBCRI Testing Concept Process

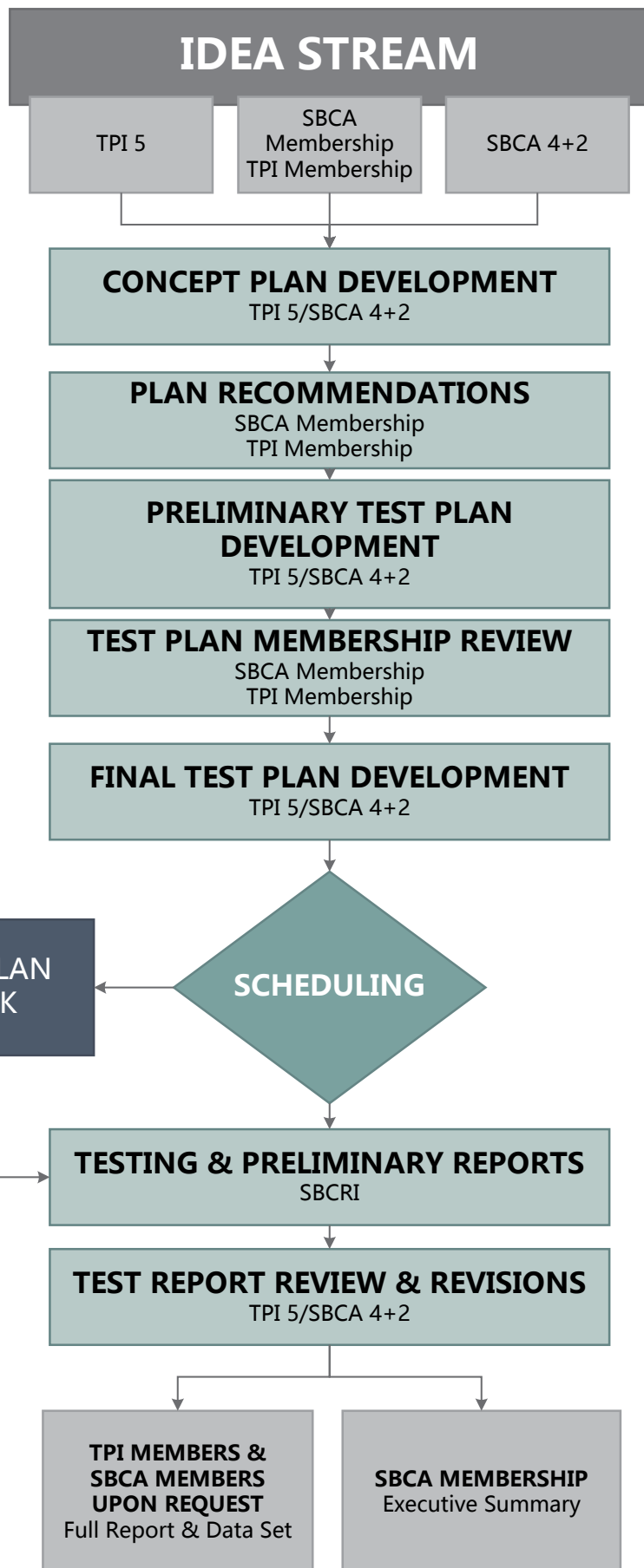

## Top Chord Bearing Reaction Testing

The current *ANSI/TPI 1-2007* standard limits the allowable reaction for top chord bearing trusses. The purpose of this testing is to determine if the tabulated end reactions can be increased based on test data. All tests will conform to the requirements in *ANSI/TPI 1-2007* Figure 7.4-1(a) and (d). The trusses will be designed to isolate the failure mode to the end condition, in order to ensure the best value for our testing.

## Toe-Nail Connection Testing

The *National Design Specification for Wood Construction (NDS)* provides a method for calculating the strength of a toe-nailed connection for withdrawal and lateral loads. The method in the *NDS* was used to develop the uplift and lateral resistance capacities in Table B8-1 in the *Building Component Safety Information (BCSI)* book.

The *NDS* applies a toe-nail factor ( $C_{tn}$ ) of 0.67 and 0.83 to withdrawal and lateral design values, respectively. These factors reduce the strength of a toe-nailed connection compared to a face-nailed connection. However, the *International Residential Code (IRC)* "assumes that the toe-nail factor does not need to be applied to roof-to-wall connections" (NAHB Research Center, 2008). Eliminating or increasing this adjustment factor would allow for much higher connection capacities than currently published in *BCSI*.

## Truss Ply-to-Ply Connection Testing

Multi-ply trusses typically support a side load attached to one ply and must be connected together to transfer the load from ply-to-ply. No guidance is given in *TPI 1* on what type of load distribution is appropriate, how to design the connections between plies, or how frequently the connections need to be placed. Some of the factors that may influence the failure of a multi-ply truss connection are:

- Deflection of the truss
- Bending of chord members between panel points
- Spacing of concentrated loads
- Friction between truss plies
- Connection slip

A connection design process that accounts for these factors needs to be developed to optimize ply-to-ply connections.



## Overcoming Truss Installation Obstacles

A framer's perspective on addressing the challenges of installing complex components.

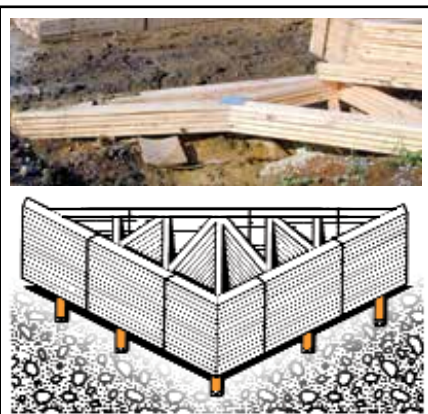

Figure 1. The top photo above shows trusses being improperly stored on uneven ground. The bottom image illustrates proper horizontal storage, with blocking placed at a sufficient height beneath the stack of trusses to minimize lateral bending and to lessen moisture gain from the ground. (Source: BCSI)

### at a glance

- Today's complex truss designs can present significant installation challenges to framers if there isn't good communication between the framer and the manufacturer.
- From storage and lifting pick points to critical bearing conditions, safe handling and installation practices need to be effectively communicated to installers.
- During the design phase, manufacturers can help ensure smooth installation by considering the framing challenges a complex design may create and facilitate cross communication between parties.

Framers have access to better materials, tools and methods today than they did 25 years ago. The natural evolution of construction techniques over time is like any long-standing process; craftsmen learn to accomplish the same task in a more efficient way based on experiences, trial and error, and the technology available. The most prominent change in the construction industry in the last 45 years was the birth of component manufacturers. With an infinite number of possible truss designs, framers were able to build stronger structures at a faster rate without the need to assemble every member by hand. However, access to unlimited truss designs does present complications to framers who must install and secure trusses, regardless of how complex they may be.

One commonly overlooked question is: where can trusses be stacked and stored on a jobsite? The answer, with ease of access during installation in mind, is that it differs on each jobsite. In short, trusses need to be stored out of the way so they don't obstruct framers working or risk being damaged (see Figure 1). However, they need to be near enough to be ready for installation and stored in the correct order to do so efficiently.

Positioning trusses proves difficult on many jobsites, but doing so on an urban, multi-story complex with trusses greater than 40 feet in length is its own kind of monster. The most important thing a crew can do before flying trusses is to *study the plans*. Nothing replaces knowing what the design plans call for and how to position framing members in the correct order on the jobsite. When the time comes to lift trusses into the waiting hands of framers, the process is safer and smoother when everyone is informed and materials are organized.

During erection, crews can run into problems with joint locations and truss plate size as it relates to lifting points. Many truss companies manufacture trusses with oversized truss plates, given that smaller plates can be damaged during the lifting process. Oversized plates give greater strength and stability to the truss member connection points during lifting. It's important to remember trusses are designed to support roof loads, not loads applied by framers when they're being lifted, dragged across top plates, and set into position. Crews should understand the best lifting points on different truss designs and stay away from putting undue stress on critical members, joints and plates. Above all, trusses should maintain their rigid form when lifted (see Figure 2). Trusses bent like noodles are at risk of being damaged or permanently broken (see Figure 3 below).

Fortunately, due to the advancement in technology mentioned above, once trusses are raised into place, installation is straightforward (in theory). A framer's task is to align one end of the truss onto the wall top plates, keeping it straight at the heel, tack it down, and repeat on the other side. When subsequent trusses have been set, pitches are aligned, sheathing ties all the chords together, and the task is done. Simple, right? Wrong. It can be simple, yes, but when complex truss designs are factored into



Figure 3. Improper handling of trusses can result in permanent damage.



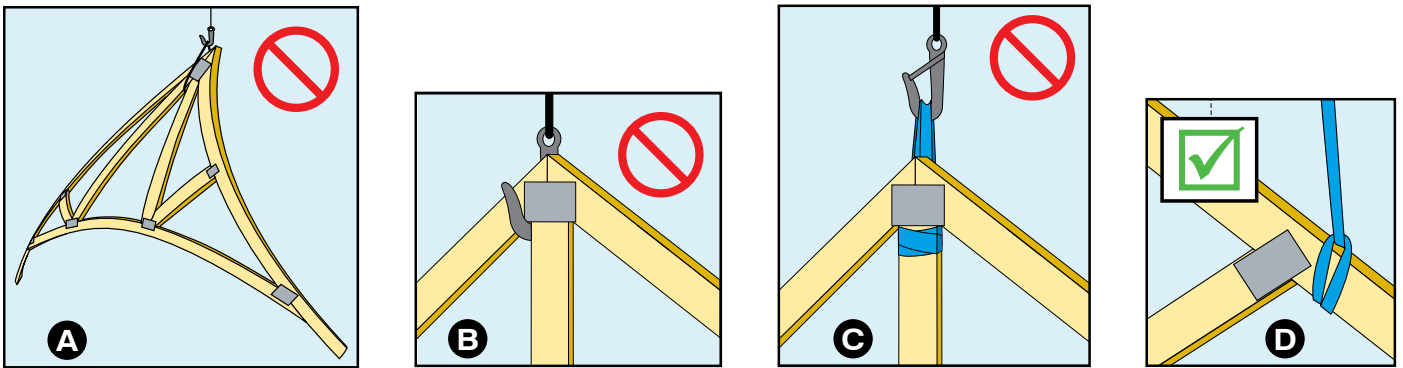

Figure 2. Take care when hoisting trusses to avoid lateral bending (A) and damage to the chords, web members and/or connector plates. Do not lift singles trusses by the peak using a hook (B) or by the webs (C). Connect lifting devices to the truss top chord with only closed-loop attachments (D). (Source: BCS)

the building equation, the simplicity soon disappears.

So then, what are some of the most difficult truss designs to install? In my experience, flat roofs with slight pitches can pose a real problem. Architects may call for a ¼:12 pitch, but it would be advantageous to encourage a ½:12 pitch to eliminate the possibility of standing water and other drainage issues. Although in this case it is more of a truss design issue, as framers, we must be cognizant of the intent of a truss design and the impacts of that design on our installation practices.

Another difficulty with flat roof designs is parapet configurations. Parapets can either be manufactured into the truss design, or they can be manufactured as stand-alone pieces (see Figure 4). In my opinion, it's more difficult to set trusses when parapets are part of the truss design because you're not only concerned with adjusting the roof line, but also ensuring the parapet is plumb. What's worked well over the years is to install them after the main roof is complete, alleviating the difficulty of having to set competing angles.



Figure 4. Parapets can either be manufactured into the truss design (as shown above), or they can be manufactured as stand-alone pieces.

Roof designs with multiple spans and hips can also be difficult to install. In most cases, the difficulty arises from access, stacking the trusses, and the order that the trusses come off the stack.

Accurate truss design and layout plans are very important in many cases, and it's a good idea to show start points for layout so that the hip and valley points can be located. One major point of emphasis I'd like to stress from my years setting trusses is the utilization of drop-chord hip trusses. By dropping the top chord of a hip truss, a framer can install lay-in gable trusses, which sit flush with the top chord of the trusses on the opposite side of the hip, giving framers an even surface to sheath. Additionally, the framing contractor can be more precise in his configuring hips, valleys and slopes.

Continued on page 10

## NEW Wall Panel Equipment

---





**WASSERMAN & ASSOCIATES, INC.**

Toll-free: 800-382-0329  
[sales@wasserman-associates.com](mailto:sales@wasserman-associates.com)

- Framing Table with Programmable Single Tool Panel Bridge
- Robust construction with long-term reliability & performance
- \$59,000 including Installation Support in the US & Canada

[wasserman-associates.com](http://wasserman-associates.com)

## WEB REINFORCEMENT FOR SINGLE-PLY TRUSSES<sup>1</sup>

Specified CLR	Size of Truss Web	Type & Size of Web Reinforcement				Grade of Web Reinforcement	Minimum Length of Web Reinforcement	Minimum Connection of Web Reinforcement to Web
		T	L	Scab <sup>2</sup>	I			
1 Row	2x4	2x4	2x4	2x4		Same species and grade or better than web member	90% of Web or extend to within 6" of end of web member, whichever is greater	16d (0.131x3.5") nails @ 6" on-center <sup>2</sup>
	2x6	2x6	2x6	2x6				
	2x8	2x8	2x8	2x8				
2 Rows	2x4	---	---	---	2-2x4			
	2x6	---	---	---	2-2x6			
	2x8	---	---	---	2-2x8			

<sup>1</sup>Maximum allowable web length is 14'.

<sup>2</sup>For Scab Reinforcement use 2 rows of 10d (0.120x3") nails at 6" on-center to attach reinforcement to web

Table 1. This table from *BCS/* provides generic reinforcement information that can be used in the event that information from the Truss Designer is not available. The reinforcement information in this table is limited to the reinforcement of Webs in single-ply Trusses in which there is either one or two rows of CLR specified on the TDD. This information is conservative and a more efficient means of reinforcement may be available from the Truss Designer.

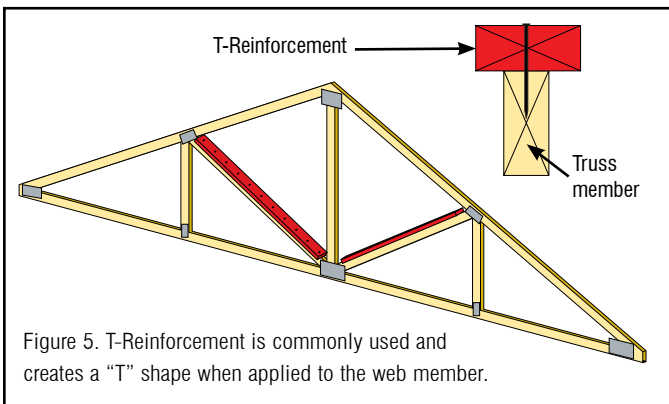

Figure 5. T-Reinforcement is commonly used and creates a "T" shape when applied to the web member.

### Framer Viewpoint

Continued from page 9

Access to cantilevers or high-pitched vaults is another major obstacle for framing crews. Not only are these designs awkward to handle, but bracing techniques are generally more unconventional. On those designs with intricate webs, experience has proven that T-braces are a necessity to brace appropriately (see Figure 5). T-braces are used as an alternative to the combination of continuous lateral restraint and diagonal bracing when those techniques cannot be used. The T-bracing method generally uses more wood to brace, which increases cost, but in intricate web designs, it is the only way to properly resist buckling. (See Table 1 to help determine what size T-bracing is required.)

Here are a few more examples of truss designs that are difficult to install, and key points to help framers:

- 1. Coffered:** Framers must be attentive to align inside angles (ceiling) with outside pitches (hips) in order to set these correctly. Anytime you have to align interior ceilings and also manage complexities on the exterior roof, it becomes a difficult task.
- 2. Bowstring:** The end goal here is to have a round roof deck even though the truss is built with straight chord members.

It's important to pay attention to the top chord angles, so when it comes time to brace and sheath, the sheathing sits correctly on the chords.

- 3. Attic:** Align inside angles with outside angles, similar to Coffered trusses.
- 4. Scissors and Half Scissors:** Stabilizing and bracing can be tricky because the bottom chord isn't horizontal. Due to this, access is limited—framers can't just walk up the truss. In many cases, scaffolding is the best route to position yourself for bracing between web members.
- 5. Vault and Studio Vault:** In many cases, vault designs do not extend the entire length of a room and may transition into parallel chord trusses or other designs with horizontal bottom chords that transition back to a flat ceiling. In that case, stabilizing and aligning the walls is paramount to ensuring first, the trusses are set accurately at the correct height and angle, and second, the meeting point dimensions between the two truss designs is within those called for in the design plans.

To overcome difficulties presented by the designs discussed above and all other types of complex truss designs, framing crews should be familiar with the critical points: hips, offsets, valleys, hold dimensions for vaults, etc. Again, *studying the plans* and developing a redline set for critical dimensions and details is the best way to overcome obstacles. Above all, if the design is still unclear, *clarify the plans* with the component manufacturer/truss designer. Technology not only makes design capabilities endless, but also displays the answers with a click of a button. Waiting on installation in order to ask a simple question is far better than installing trusses incorrectly. A framing crew that follows these guidelines will be efficient yet maintain quality. In the long run, that means more opportunities for work, and we can all agree that's good news. **SBC**

*George Hull is President of Hull Associates, LLC in Arlington, TX. He brings more than 35 years of framing experience as the first Chairman of the National Framers Council. For details about NFC, visit [framerscouncil.org](http://framerscouncil.org).*

Coffer/Tray

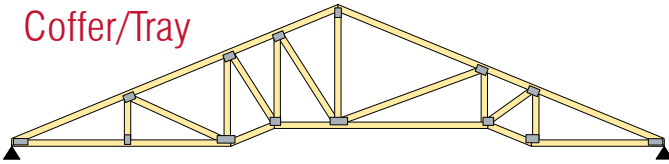

Bowstring

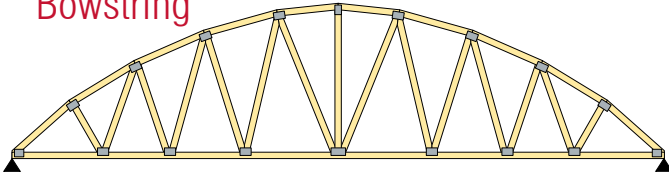

Attic

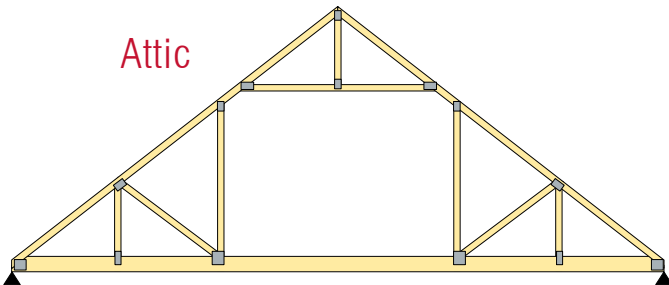

Scissors

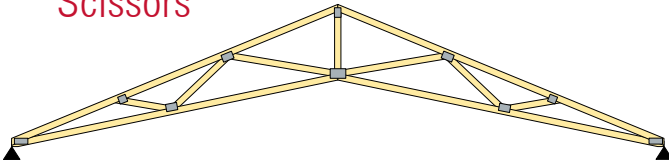

Half Scissors

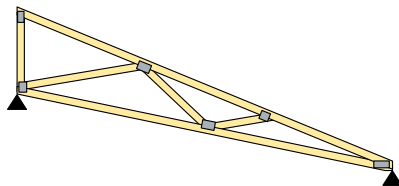

Vault

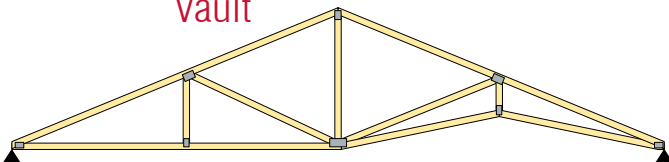

Studio Vault

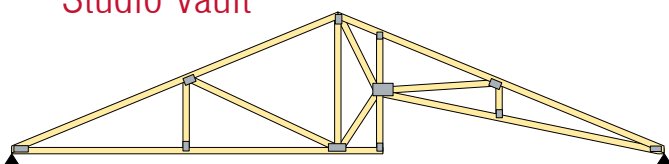

## Machinery. Parts. Service.

- ✓ **New, state-of-the-art** component manufacturing & material handling systems *by the industry leading manufacturers.*
- ✓ **Used & Reconditioned** machinery. Eide's warranty on reconditioned equipment meets or exceeds the new machine warranty.
- ✓ **Installation & Operator Training** included or available with any equipment purchase.
- ✓ **Table Retrofit** and upgrades for WizardPDS®.
- ✓ **Parts & Supplies.** Our parts department stocks thousands of parts and supplies for most brands of cutting and pressing systems. Custom and obsolete parts fabrication is our specialty.
- ✓ **Service & Repair.** Our service department offers complete repair, rebuilding & retro-fit services; in-house or on-site.

We know machinery.



Machinery ~ Supplies  
~Since 1927~

# Taking Trusses to New Heights

Bringing Ingenious Design, Versatile Configurations & Collaboration to a Project

by Emily Patterson

Things are looking up for The Truss Company. Overall, sales are strong, and a new location will soon open its doors in Pasco, WA. A bright future often brings new opportunities, much like The Truss Company's Sumner, WA, office encountered with the Golgotha Baptist Church project in Midland, WA (see Figure 1 on facing page).

"This project is definitely outside the norm for us," said Matt Yokes, Sales Representative for The Truss Company. In many ways, the project required some of the most important qualities that component manufacturers and the trusses they design and manufacture can bring to any project: ingenious design, versatile configurations, and the ability to work with other trades to make the completed structure a success.

## Ingenious Design

While a church project isn't something new for The Truss Company, this particular church did present some new design scenarios. In particular, the building designer wanted to use trusses for the steeple. "The steeple were a first for us, as far as building something like that out of trusses," said Yokes.

"Steeple are usually stick built, but for this project, they wanted to try to do it with trusses. There's a lot of complexity to get pre-manufactured trusses to work," said Jake Lucas, Truss Designer on the project.

Following the building plans, The Truss Company's design team suggested a false-style decorative steeple constructed of trusses (see Figure 2 and 3 at left). In addition, one of the steeple also needed to serve as the base for a 4-ft.-tall stainless steel cross, so the trusses were designed to form a small platform for the cross to sit on (and attach to) at the top of the steeple.

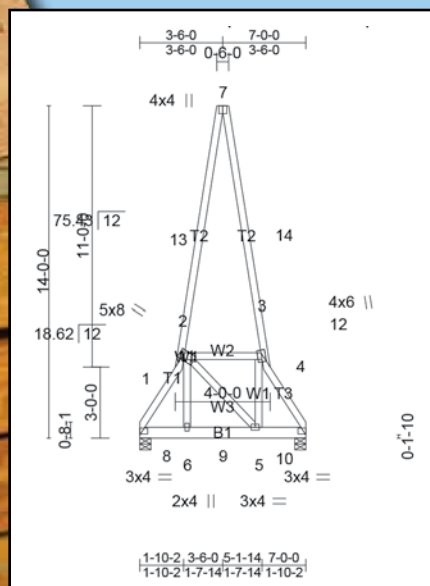

Figure 2 and 3. The Truss Company designed a decorative steeple built of trusses. Note the top of the steeple forms part of a small platform for a 4-ft.-tall stainless steel cross.

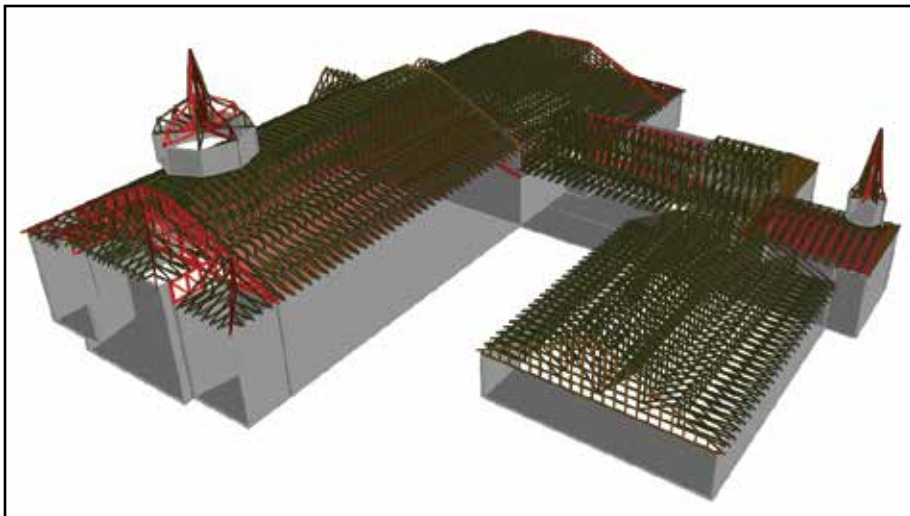

Figure 1. The 18,000 sq. ft. Golgotha Baptist Church includes 68-ft.-span scissors trusses, vaulted ceilings, large stubbed attics and steeple trusses.

In order to make the steeple design work, special care needed to be taken in the design of the trusses below the steeples, which spanned 60 ft. with no interior bearing. “We had to make changes to the trusses underneath, in order for the trusses to work at a 2 ft. o.c. spacing, due to the span of the trusses being so long,” explained Yokes.

The Truss Company looked at a few different hanger options for the steeples. Original plans called for a custom hanger solution, but when cost and the hanger specs needed for the “steel buckets” became an issue, the company chose to stub the trusses back to the girders and use standard hangers. “In the end, it was a bit more installation for the framer, but we eliminated some extra cost and high concentrated loads we would have had to incorporate into the truss design,” said Lucas.

### Versatile Configurations

Scissors trusses make up much of the church’s roof, with many completed scissors running over 15 ft. tall (see Figure 4). Due to their height, almost all of the scissors trusses on the project were capped (i.e., piggybacked). Capping the trusses made sense both from a design, as well as a production and delivery, standpoint. “Our roller press can go up to 14 ft., but we try to keep it below 13 ft., so it’s easier to transport to the jobsite,” said Lucas. The Truss Company used its engineering program to generate the design of the cap trusses, which were piggybacked at the jobsite.

Continued on page 16



Figure 4. Installation of a scissor truss. With a cap truss installed, many of the project’s scissor trusses were over 15 ft. tall.

## Serving the Truss Industry Since 1987

New & Used Models in Stock



For over 20 years, Lakeside Trailer has led the way in the component trailer industry with innovative ideas to assure your delivery operations remain efficient in today’s competitive market. With more than 1700 truss trailers to our credit, Lakeside has perfected ways to reduce or eliminate your transportation concerns.

**LAKESIDE**  
TRAILER MANUFACTURING, INC.

573/736-2966 • 573/736-5515 fax  
www.rollerbed.com • lee@rollerbed.com

## LOOKING FOR THE RIGHT EQUIPMENT PARTNER?

— *Your search* —  
*can end right here.*

Matching you with the right wood component equipment. New or used. Through thick or thin.

www.WoodTrussSystems.com  
765-751-9990

**Wood Truss Systems**  
inc.  
MANUFACTURERS’ REPRESENTATIVES



**MiTek<sup>®</sup>**

**Better Technology. Better Building.<sup>SM</sup>**

A man with a beard and glasses is shown in profile, looking at a computer monitor. The monitor displays a technical interface with various graphs and data points. The background is a control room with various equipment and a window showing a bright outdoor scene. A large blue diagonal shape is overlaid on the bottom right of the image.

YOUR NEW SAW ONLY NEEDS ONE GUY  
**BUT COMES STANDARD  
WITH A TEAM.**

**O**ur state-of-the-art saws include the technology to cut any truss or panel member with speed and precision. They also include an entire support team. Your MiTek Machinery Tech Reps are real people available on the phone, as well as on-site, ready to help keep your saws humming and your presses rolling. You might even consider them productivity, personified.

Visit [MiTek-US.com](http://MiTek-US.com) to find out more about your personal support team.

**IT'S YOUR  
LABOR,  
KNOW YOUR  
COSTS.  
EVERY JOB.  
EVERY TRUSS.**

**Labor Tracking  
Software for the  
Truss Industry**



Sundial Software  
480.365.8698 • sundialsoftware.net

**CALL TODAY FOR A DEMO**



Figure 5 and 6. The Truss Company's team designed an intricate 4-ply girder truss, over 15 ft. tall with a cap truss, for the area next to the attic and mechanical platform.

## **Taking Trusses to New Heights**

Continued from page 13

### **Working with Other Trades**

The building's mechanical plans also played a key role in the roof design. Multiple spans and ceiling heights over the fellowship hall made it especially important for the plate heights to be set correctly. While an individual truss could be designed to be structurally sound, The Truss Company's team knew that an unexpected mechanical requirement could lead to callbacks and field fixes. "If it's wrong, it's a big problem. I wanted to get it right the first time," said Lucas.

"We took a good hard look at the mechanical plans," said Lucas. The Truss Company followed up with the contractor, who recommended the truss manufacturer work directly with the mechanical contractor. That collaboration paid off and helped both trades work through issues before the trusses were built. "Through phone and email, we were able to send [the mechanical contractor] nice pictures of everything and have him approve them," said Lucas.

Based on information from the mechanical contractor, The Truss Company's team

Precision Equipment MFG delivers premier truss trailers specifically designed to accommodate the challenging demands of the building industry. Precision Equipment MFG offers multiple truss trailer sizes in the gooseneck, standard and extendables. Precision Equipment MFG incorporates industry leading manufacturing components and features to ensure an excellent return on your investment.

**Toll Free: 800.237.5161**  
**Phone: 701.237.5161**  
sales@precisionequipmfg.com  
www.precisionequipmfg.com



designed an intricate 4-ply girder truss, over 15 ft. tall with a cap truss, for the area next to the attic and mechanical platform (see Figure 5 and 6).

Much like the positive experience with the mechanical contractor, both Yokes and Lucas said communication ran smoothly on the project. "We submit drawings so the architect and engineer can review, supply comments, and we can work through changes," said Yokes.

"It's nice to work with people who really know what they're doing," said Lucas. "They have enough notches in their belt. The contractors on this project were very experienced. You're getting an experienced and reputable crew. We worked hard to meet them in the middle."

### Conclusion

A company "first," designing the steeples out of trusses, also proved to be a good barometer for how the project would progress at the jobsite. Coworkers who happened to drive by the site on their way to work kept others in the office updated on the stages of construction. "I was happy to hear the steeples went up so cleanly," said Lucas (see Figure 2). "They saw the steeples were sheeted, so we knew it went well." **SBC**

*Want to see your company featured in SBC Magazine? Send us hi-res photos and project details on your company's unique project, and you just might see your company highlighted in an upcoming issue. Email ideas to editor@sbcmag.info.*



# Thank you

to these program advertisers for their commitment of support in 2015!

### Gold Advertisers

Alpine  
Clark Industries Inc.  
Eagle Metal Products  
Eide  
Lakeside Trailer Mfg.  
MiTek  
Precision Equipment MFG  
Simpson Strong-Tie Co.  
Wood Truss Systems, Inc.

### Bronze Advertisers

Anchor Peabody  
BlueLinX Corporation  
Composite Panel Systems LLC  
Georgia-Pacific Engineered Lumber  
Sundial Software, LLC  
Wasserman & Associates, Inc.

### Silver Advertisers

Hundegger USA, L.C.  
PA & IN Lumbermens Mutual Insurance Companies

● For details about advertising, visit [advertise.sbcmag.info](http://advertise.sbcmag.info) or call 608.310.6729.

## BUSINESS IS GOOD... SO IS THE DOLLAR!



Rather than debate whether or not time is money....JUST SAVE BOTH!

Extremely efficient, incredibly innovative and still delivering the industry's lowest cost of ownership...ESPECIALLY NOW!

- 24' Automated In-Feed (394 ft/min)
- 24' Automated Out-Feed
- 5-axis saw 28" Saw Blade / 12 hp Motor
- Cuts Stacked 2x at 4 high
- Bevels from 0° to 90° - All Angles
- Electronic controls and operator console
- Integrated waste system under the saw
- Remote diagnostics/assistance System
- Free Software updates for LIFE!!

**\$209,000**

Includes:

Duty  
Shipping (anywhere in the lower 48)  
Install and training



www.hundeggerusa.com - 435.654.3028

# MOMENT

## Why Bigger Plates Are a Good Thing

# resistance

by Dave Brakeman, P.E., S.E. & Sean D. Shields

Consider for a moment the basics of manufacturing a truss. Based on SBCA's 2012 Financial Performance Survey, lumber accounts for roughly 40 percent of the total cost. Plates account for about eight percent of the total cost. Design and production labor account for 30 percent, and delivery, sales and overhead account for the remaining 22 percent (these are rough industry averages). All other things being equal, if you could decrease your lumber costs by a few percentage points while raising your plate costs a small amount, would you take the trade-off?

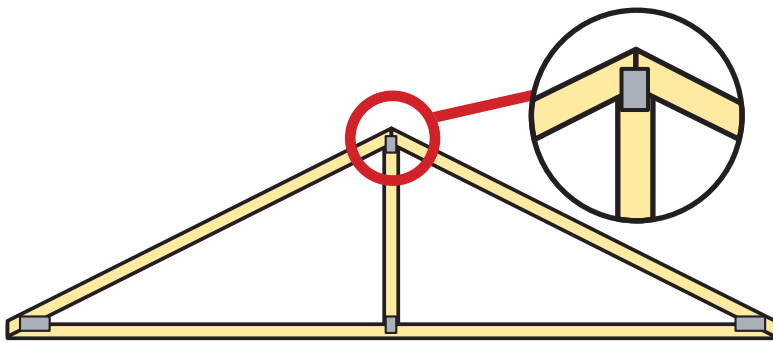

Figure 1. The peak joint of a kingpost truss.

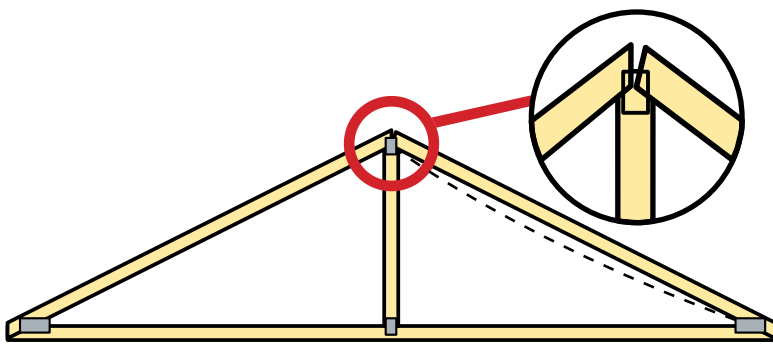

Figure 2. Bending moment forces as load is applied to the top chord of a kingpost truss.

This is exactly the question component manufacturers (CMs) and plate suppliers asked themselves in the late 1990s. The solution they found, to account for the bending moment resistance of metal connector plates (MCP), may or may not be well understood. Figuring in the MCP moment resistance allows for more even distribution of that stress throughout the wood member, typically resulting in a lower maximum CSI for that lumber member. The impact of this redistribution is significant to truss design in that it means that, in certain cases, a slightly larger MCP will allow a lower lumber grade to be used. This article will attempt, through simple terms and a few examples, to explain how and why.

### Understanding Moment

What are bending moment forces? One of the easiest examples may be to look at a peak joint of a kingpost truss (see Figure 1).

As load is applied to the top chords of this truss, those chord members deflect and bend downward/inward. When the top chords deflect, the ends of the top of the chord members at the peak of the truss experience rotation, causing the lumber ends to move away from each other at the top of the peak joint, creating gaps in the joint (see Figure 2).

The top chords of that truss must be designed to resist this applied bending and rotational load. In this

**Consider how factoring joint stiffness could save you money.**

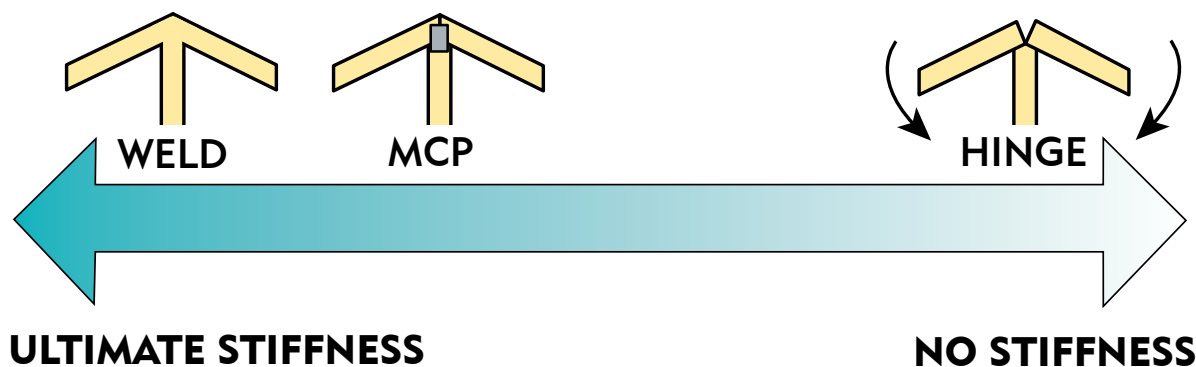

Figure 3. If stiffness were plotted on a spectrum, at one end there would be ultimate stiffness, and on the other, zero stiffness.

simple example of a kingpost truss, the span is a significant factor, as well as the strength of the lumber used in the top chords and the ability of the metal plate at the peak joint to resist these bending and rotational (bending moment) loads.

Let's take a small step back and look at the joint. Another way of thinking about the MCP's ability to resist the rotation of the end of the wood member is to talk about it in terms of stiffness. If stiffness were plotted on a spectrum, at one end there would be ultimate stiffness, and on the other, zero stiffness (see Figure 3). Ultimate stiffness could be achieved if there was some way to weld the ends of the top chord and kingpost members together, as if they grew that way.

At the other end of the spectrum would be something akin to the absence of stiffness, like a hinge. If all the ends of the chord and kingpost members were allowed to rotate freely, there would be little to no stiffness.

Obviously, a MCP provides stiffness or resistance to the bending moment rotation. It's also clear that the MCP is closer to the "weld" end of the spectrum versus the "hinge" end, but where exactly in this spectrum does it fall?

This is an important question because, instead of having to design a truss by relying entirely on the strength or stiffness

of the wood used in the top chord, the MCP's stiffness can, and should, be accounted for in helping the lumber resist the rotational loads in the truss design.

### Accounting for Moment

Prior to the publication of *ANSI/TPI 1-2002*, a MCP's ability to resist bending moment (rotation) forces was not typically factored into the design of a truss. While plate suppliers and CMs who conducted their own proprietary testing could factor in this resistance under *TPI 1* Section 1.3.2 (see sidebar below), which enables anyone to use their own test data to establish alternate designs as equivalent to the standard, this was not widespread.

Continued on page 20

## 1.3.2 Alternate Provisions.

### 1.3.2.1 Materials, Assemblies, Structures, and Designs.

This Standard does not intend to preclude the use of materials, assemblies, structures, or designs not meeting the criteria herein, when they demonstrate equivalent performance for the intended use to those specified in this Standard. The use of such alternate provisions shall be indicated on the Truss Design Drawing.

**AT THIS RATE, IT WON'T BE LONG BEFORE MANUAL SAW FEEDING IS COVERED WITH DUST.**

Compatible with any linear-feed saw, the Wood Runner™ automated lumber retrieval system increases production by 30%, while reducing labor by half. Wood Runner sets the pace of the operator, and ensures accurate lumber selection every time. Visit [www.apexmw.com](http://www.apexmw.com) or call 507-322-3700 to learn more today.

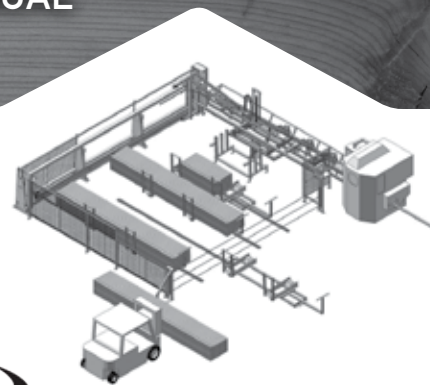

## Moment Resistance

Continued from page 19

Recognizing that MCPs provide joint stiffness and resistance to rotation, testing of plates was undertaken in the late 1990s to determine their ability to resist moment forces. According to the *ANSI/TPI 1-2014 Commentary*:

The results of the tested specimens were compared against three theoretical models used to predict the ultimate moment capacity of the steel-net sections.

Through that comparison, a formula was developed to account for a MCP's ability to resist moment forces. That formula was included for the first time in Section 8.7 of the *ANSI/TPI 1-2002* edition. Soon after this, plate manufacturers incorporated the formula into their truss design software. While this occurred over a decade ago, the practical application of the formula wasn't fully realized until years later.

In general, CMs didn't begin utilizing this equation until their local building codes referenced *ANSI/TPI 1-2002*, which began with the *2006 International Residential Code (IRC)*. Further, the formula has gone through some revisions. Again, according to the *ANSI/TPI 1-2014 Commentary*:

The equations in Section 8.7.1, originally included in the 2002 specification in a slightly different form, are developed from the most accurate model from this research as validated by testing. Subsequent use and further research showed the need for modification of this method to recognize the interaction between axial compression and moment stresses and to recognize the effect of plates located off center.

## Application of the Formula

So what does this formula mean for CMs from a practical standpoint? Looking at the peak joint again, the stiffer that joint is, the more it is able to resist the rotation from the bending moment force. From a design perspective, the maximum critical force of the top chord member is then reduced because it is redistributed between the chord and the MCP. Figure 4 shows a graphical depiction of the force that the lumber has to resist when a MCP provides no stiffness.

Figure 5 shows a graphical depiction of the much smaller forces that the lumber has to resist when a MCP provides rotational stiffness.

In summary, because the moment force formula is now incorporated into the design software, from a design perspective, the lumber chord member no longer has to resist the applied load all by itself. By factoring in the MCP joint stiffness, the CSI of the top chord is reduced and a lower grade of lumber may be sufficient to resist the applied load. Let's look at two case studies to see the impact this has.

## Case #1 Kingpost

Let's continue to look at a kingpost truss. If the moment force formula is ignored and the joint is treated as it theoretically and historically was, the truss joints would be designed using a hinge model (providing little to no rotational stiffness) and results in the truss design seen in Figure 6 on page 22.

Using a 4x4 plate at the peak, 2.5x6 plates at the heels, and a 2x4 plate at the D joint, the top chords would need to be constructed of 2x4 2700f – 2.2E MSR SP, the bottom chord would be 2x4 SPF #1, and the kingpost would be 2x4 SPF stud grade.

If the moment force formula was used, and MCP stiffness was factored into the design, the truss would be designed using partial fixity and would result in the truss design seen in Figure 7 on page 22.

If the plate sizes of the peak and heels were increased slightly, the top chord material needed to resist the applied loads could be reduced to 2x4 SPF 1650f – 1.5E, while the bottom chord and kingpost material would remain the same. This reduction in the grade of top chord material represents a significant cost savings to a CM. Let's look at another example.

## Case #2 Modified Queen

Here's a fully triangulated queen truss. Again, if the moment force formula is ignored and the joint is treated as a hinge, the truss design would result in the truss design seen in Figure 8 on page 22.

Using a 5x5 plate at the peak, the T2 and T3 segments of the top chord would be constructed of 2x4 SPF 2100f – 1.8E, while the remaining top chord and bottom chord material would use 2x4 SPF 1650f – 1.5E, and the webs would be 2x4 SPF stud.

Continued on page 22

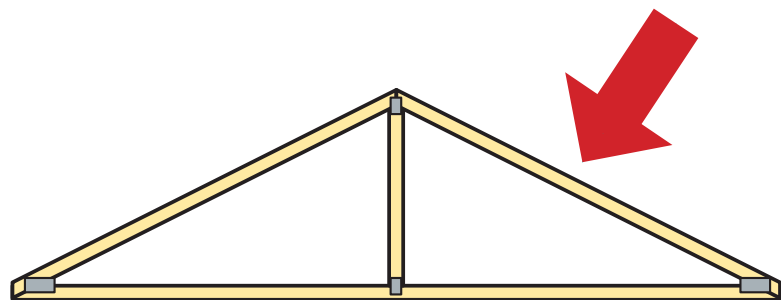

Figure 4. The force that the lumber has to resist when a MCP provides no stiffness.

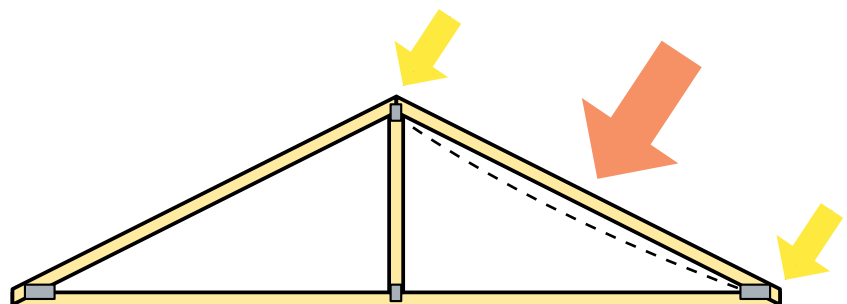



Figure 5. The much smaller forces that the lumber has to resist when a MCP provides rotational stiffness.



# ENGINEERED and TESTED Solutions



Lateral  
Systems



Structural  
Connectors

Integrated  
Component Systems



Fasteners

Simpson Strong-Tie is committed to delivering the most innovative products to our customers, which is why the company invests in research and testing. This commitment not only results in new products that improve building construction, but products that provide time-saving, value-engineered solutions. With more than 55 years of proven performance, customers count on Simpson Strong-Tie for innovative products, jobsite and engineering support, and unparalleled service.

We want to be your #1 supplier for truss, EWP and other structural component solutions. Let us demonstrate firsthand, contact us at (800) 999-5099 or [strongtie.com/ics](http://strongtie.com/ics).

**SIMPSON**  
**Strong-Tie**<sup>®</sup>

## Moment Resistance

Continued from page 20

If the moment force formula was used, and MCP stiffness was factored into the design, the truss could be designed as seen in Figure 9.

If the plate size of the peak was increased to 5x6, the T2 and T3 segments of the top chord could be constructed of 2x4 SPF #1/#2, while the remaining top chord and bottom chord material would still use 2x4 SPF 1650f - 1.5E, and the webs would be 2x4 SPF stud. Again, this reduction in the grade of T2 and T3 top chord material represents a real cost savings to a CM.

## Overall Material Savings

It's important to note the moment resistance formula is active and running behind the scenes in the design software (assuming your local code references *ANSI/TPI 1-2002* or later). The software automatically takes advantage of the stiffness the MCP provides. The result is that, in some cases, the software will specify larger plate sizes than it would have traditionally. This is a good thing, not because the plate sizes are bigger, but because the MCP now, in most cases, helps to lower the lumber and overall truss CSI by redistributing the maximum stress throughout the lumber members.

Again, this redistribution should allow for a lower grade of lumber to be used in a given application. As mentioned at the beginning of this article, with lumber representing roughly 40 percent of the cost of a truss, saving money on lumber will have the biggest impact on the total cost of producing that truss. In some cases, factoring in the stiffness of the MCP can also allow designers to eliminate some low force webs. Alternately, increasing

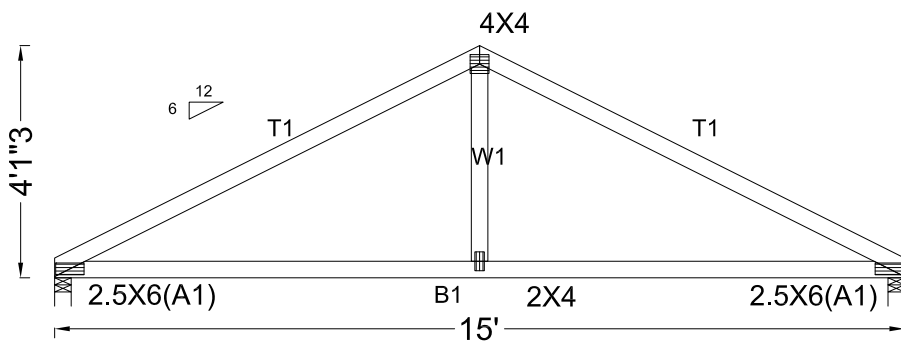

Figure 6. King post truss with joints designed using a hinge model.

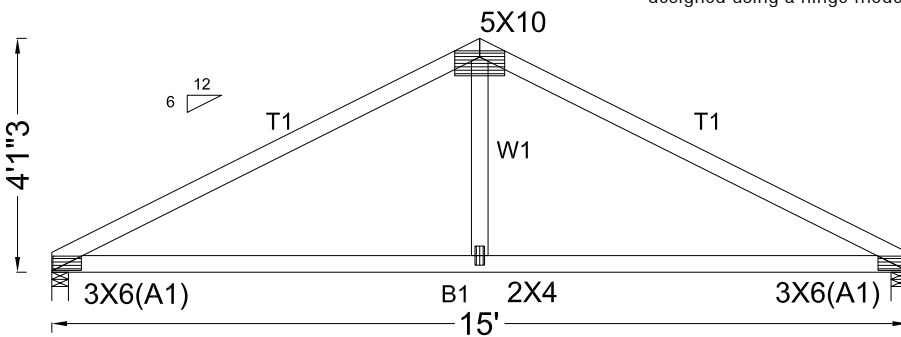

Figure 7. King post truss with joints designed using a partial fixity model.

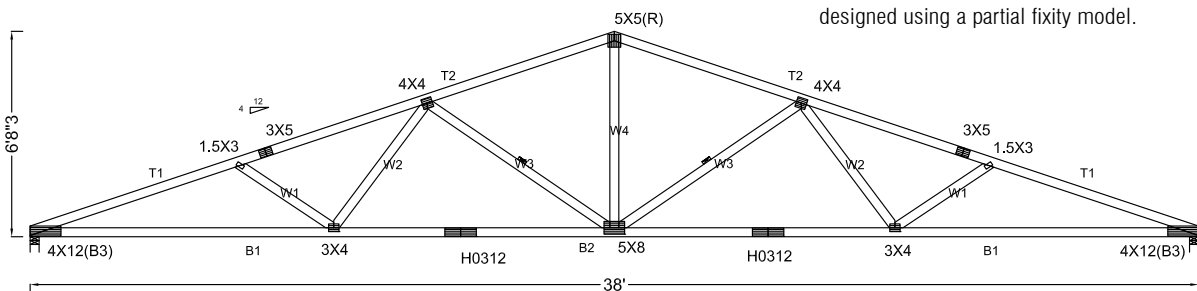

Figure 8. Modified queen truss with joints designed using a hinge model.

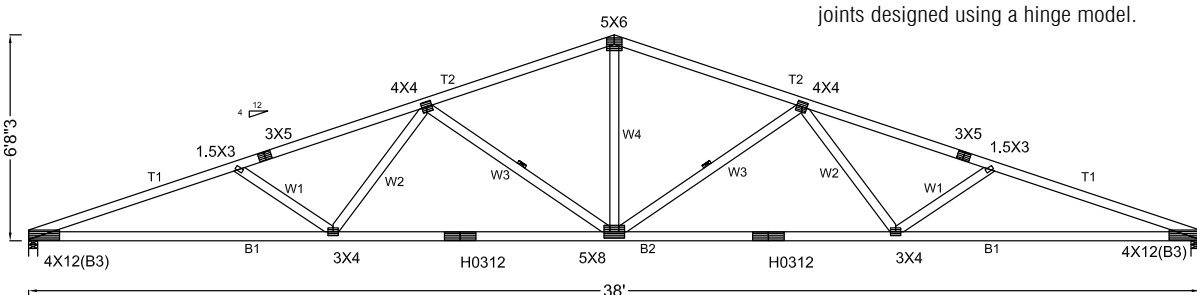

Figure 9. Modified queen truss with joints designed using a partial fixity model.

plate sizes does increase the price, but at only eight percent of the total cost, that cost impact is not as significant.

Will it provide a benefit in every case? No. In some cases, like valley sets or other short span trusses, the increased plate size now specified by the software will reduce the necessary lumber grade of wood members to a grade lower than the lowest grade of lumber carried by a CM. As a result, even though there

is a design benefit, the CM may not be able to take advantage of a lower grade because they don't keep it in stock. Taken as a whole, CMs benefit from taking advantage of the moment resistance formula through overall material cost savings. **SBC**

*Dave Brakeman is the Engineering Director for Alpine, an ITW Company. He has served as chairman of the TPI 1 project committee for the last three editions of this standard.*

# Impressive... any way you measure it.

3 Assemblers  
+ 1 WizardPDS  

---

1717 Board Ft/  
Table Hr

3 Assemblers  
+ 1 WizardPDS  

---

525 Lineal Ft/  
Table Hr

3 Assemblers  
+ 1 WizardPDS  

---

341 Pieces/  
Table Hr



See our numbers in action

[www.eideintegratedsystems.com/take-a-look-at-the-numbers/](http://www.eideintegratedsystems.com/take-a-look-at-the-numbers/)

**WizardPDS® Channels®** Your Table, automated.



Think green.  
Retro fit.  
Save green.

**WizardPDS®**  
Automated Perimeter Definition System



*We bring the best together!*

Toll free 800-344-3433 Ph. 612-521-9193 Fax 612-521-9307 [www.eideintegratedsystems.com](http://www.eideintegratedsystems.com)  
Eide Integrated Systems, LLC PO Box 11397 / 3219 North Second Street Minneapolis, MN 55411-0397

# TOP 10

# Employee Training Tools

by Ben Hershey & Sean D. Shields

Production Training

Housekeeping

Safety Communication

Reading Construction Documents

Quality Control

Driver Training

Material Handling

Designer Training

Networking Basics

Best Practices for Training & Mentoring Your Sales Team

**W**hile no one position in a company is more important than any other when it comes to training, a company's sales staff presents one of the most significant challenges in making sure they understand broad aspects of the overall component manufacturing operation. The sales team not only needs to understand the truss design and production process, they also need to be adept at understanding contracts, appreciating the company's liability position, and, above all, communicating the company's value proposition effectively in the marketplace to differentiate it from the competition and grow market share. Hence, this article will not focus on the sales process or specific techniques, but rather on best practices and training that will be most useful to the structural building component (SBC) industry.

SBC industry sales representatives come from a variety of backgrounds, and like designers, it's important to test the SBC knowledge of a sales candidate before they are hired. Just like with designer candidates, using SBCA's Technical Assessment Test Online (TATO) and Truss Basics (if you are hiring from within) will give companies a great head start in knowing the knowledge base of each sales candidate (see sidebar for more details). If a sales candidate comes out of the company's design team, they may already have certification in SBCA's Truss Technician Training (TTT) Level 1, 2 and even 3 (see sidebar), and have a strong component background. However, basic component knowledge does not guarantee a competent sales representative, so additional training will always be needed on the finer points of selling and marketing.

For a new sales representative who has no previous experience in the SBC industry, a good best practice would be to use the SBCA Truss Manufacturing Orientation (TMO) training program as an introduction to augment an internal company orientation program (see sidebar). Providing good fundamental information on the industry and then basic knowledge of component design is another good step, which can easily be accomplished with the SBCA Truss Basics program. Many component manufacturers (CMs) use these programs in combination with their own orientation programs to make sure that a newly hired sales representative gets a good start in the industry.



As suggested with truss designers (see April issue), teaming a new sales representative with a seasoned salesperson as a mentor will provide them with guidance not only on company policy, but also on reading blueprints, understanding contracts and working with customers. This practice of mentoring is sometimes neglected, which can lead to sales representatives making easily avoided errors. Those errors can take extra time, effort and resources to fix. There are certainly positive aspects of learning on the job, and gaining knowledge through mistakes is always an important part of that process. However, mentoring will help ensure mistakes are only made once, and big mistakes that could cause real harm for the company are avoided.

Mentoring should be viewed as an opportunity to learn from those in the company who have "mastered" company policies, and are





Careful in reading blueprints, contracts, etc. It's very important to point out that mentors don't necessarily have to be the top sales producer. Companies can sometimes make the mistake of "saddling" a new sales representative with their top producer, who may not be their best trainer/mentor. This can result in developing habits in the new representative that may not be desired. Instead, it's preferable to identify members of a company's sales staff (or management) who are well suited to mentoring, and enjoy doing it, to ensure new sales candidates get the most out of the experience.

One critical role the sales representative has is reading blueprints, contract documents and other project-related information. Knowing how to read all of these documents, and making sure the company has the most current information for a job, is not only critical for the design team, but can also be critical to the financial success of the project. The "Reading Construction Documents" article (see Nov. 2014 issue) in this series provides several best practices that can be beneficial in training sales staff.

In brief, it's important that sales representatives, first and foremost, take their time; rushing is only going to cause a cascade of errors. Second, ensure the company has the most current information from architects, engineers and builders/contractors. Even if a company has a set of drawings, a company always wants their sales staff asking the question, "Is this the most current set?" before moving forward with decisions. Train sales representatives to identify the drawings they view: architectural drawings, structural drawings, and the details associated with them. Identifying the dates on the drawings is vital because it alerts them if there are new drawings out there or incremental changes to details pertinent to sections of the building where components appear.

The primary point is that changes occur frequently, and many times, the parties involved in a project do not communicate those changes effectively. It falls on the sales representative to ask and find out if they have the current set of documents. In addition, SBCA has developed a comprehensive course for managers and sales representatives called *ORisk* that is one of the most effective ways to train employees in reading contract documents and identifying language to minimize risk and liability to the company. This is a course that may be good to have sales representative take over time. It will give sales staff the depth of knowledge they need to help guard a company against some of the one-sided language that appears in contracts, purchase orders and proposals they are asked to sign.

The best practice is to not blindly sign contractual documents, but rather to have the sales representative bring them back to the office for a full review. After going through the *ORisk* course, sales staff are better prepared to work with their customer to let

them know they want to review contracts instead of just signing



**TATO** can be used to determine if job candidates or current employees have the technical aptitude and skills required to succeed in the structural building components industry. TATO 1 is intended as a hiring tool to be used with truss technicians, sales staff and production personnel. It evaluates candidates' basic math and 3D visual skills, which are crucial for success in the sales, design and manufacturing divisions of the truss industry.

**Truss Basics** provides the same important information as TTT Level I but with less technical and time-intensive Math and Load Development sections. It is aimed at those who want to understand truss design procedures but will not be performing truss design. Salespeople, estimators, administrative staff, suppliers and construction industry professionals will benefit from this well-received course on the structural building components industry.

**TTT** Level I is an introduction for wood truss design technicians, estimators, and salespeople to acquire the design and engineering fundamentals of metal plate connected trusses. Students will perform calculations, solve problems, review presentations, and respond to interactive quiz questions interspersed throughout the sections. The purpose of the course is to examine industry design standards and factors affecting truss fabrication from design to installation. Upon completion of this course, attendees will have a better understanding of the truss design and manufacturing process, the application of trusses, basic math, trigonometry, and load development as it relates to truss design.

**TMO** is an introductory training course for anyone with little or no truss industry experience. A wide variety of topics on design, manufacturing and installation are presented, along with streaming videos, articles and access to numerous industry documents. Novice truss technicians, salespeople, estimators, administrative staff, suppliers and construction industry professionals will benefit from this introduction to the structural building components industry.

them. The important next step is ensuring the sales team is effectively going over documents in meetings and talking through language before they are signed. Some companies will have a single staff member experienced in contracts, or they will have their attorney review all the contracts (we will cover this issue in a future article). Often, those who review contracts go over new terms with the sales team on a periodic basis to keep them abreast of new contract language and other risk management approaches everyone needs to know.

The best part of a mentoring program is coaching a new sales representative on what the company's value proposition is for its customers. Every company prides itself on something it can do that competitors may not do; it's important to make sure this is communicated in the right manner. A company's value proposition is key, and coaching/teaching this to new representatives is going to be key to their success.

Training the CM's sales staff never truly ends. Fortunately, using the tools and best practices developed through SBCA and its membership to enhance an existing training program, along with a successful mentorship program, can be a very effective way to train new sales representative to be successful in the component marketplace. **SBC**

*Ben Hershey is a Past President of SBCA and Owner of 4Ward Consulting Group - Experts in Lean Management & Manufacturing. Networking Basics will be covered in the June/July issue.*

# Considering Equipment? Consider Clark.

**Stacking Systems? No Problem!!!**



We Offer **Fully Electric** Horizontal & Vertical Truss Stacking Systems

**Big Plates on Little Trusses?**

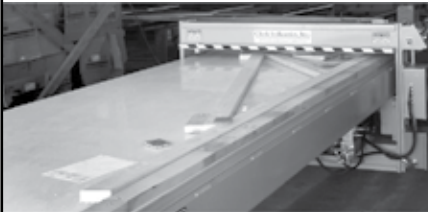

Try Our New **60 Ton** Jack Table!!!



**Clark Industries, Inc.**

816 Callan Street, Monett, MO 65708  
Phone: 417-235-7182 • [www.clark-ind.com](http://www.clark-ind.com)  
Email: [general@clark-ind.com](mailto:general@clark-ind.com)

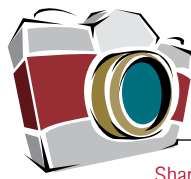

# parting shots

Share your stories and photos with us! Send submissions to [partingshots@sbcmag.info](mailto:partingshots@sbcmag.info).

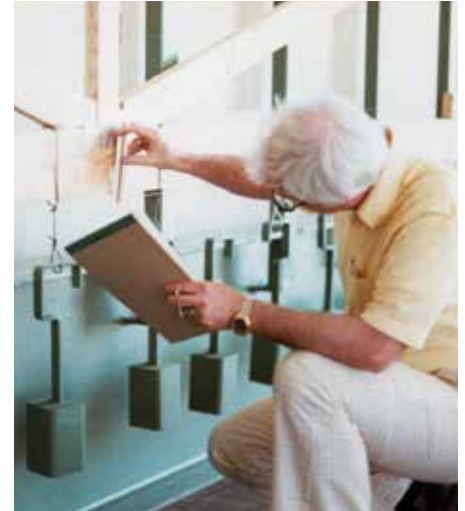

## Classified Ads

### CARPENTER PENCILS PRINTED

[www.carpenterpencilsdirect.com](http://www.carpenterpencilsdirect.com)  
800-526-6465 • Fax 973-455-7217  
[apronaz@aol.com](mailto:apronaz@aol.com)

### JOB OPPORTUNITIES - RECRUITING SERVICES

Truss & Wall Panel Industry  
[www.theJobLine.com](http://www.theJobLine.com) | 800-289-5627  
**STRICTLY CONFIDENTIAL!**

### LUMBER COVERS & PALLET BAGS

Reinforced & poly in stock  
[www.lumbercoversprotect.com](http://www.lumbercoversprotect.com)  
800-526-6465 • Fax 973-455-7217  
[apronaz@aol.com](mailto:apronaz@aol.com)

### YOUR AD HERE

A classified ad in **SBC Magazine** is the perfect way to reach the industry. Plus, when you place a classified ad in **SBC**, that ad will also be posted on our website—at no extra charge! Contact Mindy at [mcaldwell@sbcmag.info](mailto:mcaldwell@sbcmag.info) for details.

When it comes to structural testing, a lot has changed since Bill McAlpine (top left) and Ed Callahan, Jr. (top right) conducted testing in the planar test set ups you see in these photos. This essentially two-dimension approach limited the extent to which load path data could be captured. Within a building, individual components react in a variety of ways to stiffness effects, and the resulting load path is defined by all the stiffness interactions within a structural system.

Today, we can begin to identify and quantify “real world” load paths in all three dimensions through testing at SBCA’s SBC Research Institute ([sbcri.info](http://sbcri.info)). In the coming issues of **SBC Magazine**, we will be sharing testing concepts intended to help the structural building components industry more fully understand load paths in order to design and apply its products even more accurately and efficiently. **SBC**

# SBCA

# WORK FORCE DEVELOPMENT

build your skilled workforce at [wfd.sbcindustry.com](http://wfd.sbcindustry.com)

# BUILDING Innovation FRAMING SUCCESS

[bcmcshow.com](http://bcmcshow.com)



BCMC 2015 | October 20-23 | Milwaukee, WI

**BCMC**  
BUILDING COMPONENT  
MANUFACTURERS CONFERENCE

“My favorite part of BCMC was WITHOUT A DOUBT ... THE EXHIBITS, especially the equipment. Everyone that I want to talk to and everything I want to see is all under one roof!”

— RON RINDLER, RINDLER TRUSS

SAVE THE DATE & VISIT THE WEBSITE FOR EXCITING SHOW DETAILS!



I BUILD COMPONENTS.  
**I NEED A PARTNER**  
TO HELP ME  
DO IT BETTER, SMARTER  
AND FASTER.

## I can count on Alpine.

As a respected leader in the building components industry, Alpine is keenly focused on my business – like no one else. Their superior engineering, software and equipment help maximize my productivity and improve my bottom line. I rely on their smart solutions to solve my most demanding business challenges. Let Alpine show you how they can help grow your business. Experience the Alpine way of building partnerships.



(800) 521-9790 | [alpineitw.com](http://alpineitw.com)