

STRUCTURAL BUILDING **COMPONENTS**TM

THE FUTURE OF FRAMING

September/October 2008

www.sbcmag.info

BCMC – Your Business Lifeline



BCMC 2008 • DENVER, CO • OCTOBER 1-3



Planning • Evaluating • Adjusting

CHANGE SERVICE REQUESTED

Framing the
**AMERICAN
DREAM**[®]

SBC Magazine • 6300 Enterprise Lane • Suite 200 • Madison, WI 53719

PRSR STD
U.S. Postage
PAID
Madison, WI
Permit No. 2223

BRENT THORNTON
Owner, Rio Truss
McAllen, TX

IN CHALLENGING TIMES, it's more important than ever that the moves you make work hard to deliver the maximum return on your investment. When you upgrade your software, it has to deliver immediate increases in efficiency. And when you add a new piece of equipment, it has to more than pay for itself.

That's why our approach to creating success-building solutions - what we call MiTekology - makes so much sense today. It's our software, equipment, people and products all working together to deliver immediate performance enhancements and the strongest return on your investment. And it's our commitment to being a partner you can rely on to survive and thrive during these tough times.



NOW, MORE THAN EVER,
YOUR SUCCESS IS OUR SUCCESS.

SOFTWARE
EQUIPMENT
CONNECTOR & BRACING PRODUCTS
SERVICES



www.mii.com

For reader service, go to www.sbcmag.info/mitek.htm

SPEED or ACCURACY?

A HOLTEC DOESN'T COMPROMISE EITHER



Selecut®

With other package crosscut systems, cut speed has to be significantly slower to achieve nominal accuracy. Only HOLTEC systems* offer a 55-second cut with a precision of +/- 1mm (.040").

To have a successful crosscutting operation you need both. And only HOLTEC delivers both in one system. Others can take up to two minutes per cut to achieve their nominal accuracy; HOLTEC systems deliver a precision of +/- 1mm (.040") in less than 55 seconds.*

So when your goal is to increase your production, maximize your profits and minimize your costs, depend on HOLTEC. Our systems are up to 100% faster than others and the choice of more than 6,000 companies worldwide, including 1,400 in the U.S. and Canada.

Companies that don't compromise their production depend on a supplier that doesn't compromise its performance.



Transcut® II Station
\$21,999

- With a precision of ± 1mm (.040")*, the Autocut® system processes the entire unit of lumber and automatically brings it to a discharge position.
- The Autocut® is also available with our hydraulically operated Inline Package Squeezing System.
- Using a fixed-frame assembly with a moveable cutting platform, the flexible

- Selecut® meets your production needs in a limited space.
- The affordable HOLTEC Transcut® II Station will cleanly cut through a package of hard or softwood lumber in about a minute.
- The versatile Transcut® II Portable saw is designed to lower your cutting costs in light production environments.



Transcut® II Portable
\$6,900



Autocut®

INLINE PACKAGE SQUEEZING SYSTEM

HOLTEC
PRECISION CROSSCUT SYSTEMS
HOLTEC (USA) Corporation, 2802 Sydney Road, Plant City, Florida 33567
Tel.: [813] 754-1665 Fax: [813] 752-8042
Email: info@holtecusa.com
1-800-346-5832
www.holtecusa.com

*All specifications and prices are subject to change without notice. Photographs may show systems with optional accessories. Stroke speed may vary based on specie and dimension of lumber. Proper maintenance is essential for accuracy and longevity. HOLTEC, AUTOCUT, SELEcut and TRANScut are registered trademarks of HOLTEC GmbH. All other trademarks are the property of their respective owners. Price is F.O.B. Tampa, Florida. © HOLTEC (U.S.A.) Corporation. All rights reserved.

For reader service, go to www.sbcmag.info/holtec.htm



24

Church Add-On Gets Beautiful New Chapel with Components

by Joe Heinsman, PE.

The design of a new chapel showcases innovative use of components.

30

What to Expect When You're (Not) Expecting...OSHA

by Molly E. Butz

You might not know when OSHA will drop in, but that doesn't mean you shouldn't know what to expect.

36

Eco-Label Offers Viable Chain of Custody Alternative

by Libby Maurer

Are some requirements defeating the principles of green building?

41

BCMC 2008 Show Guide

Learn more about who will be exhibiting at this year's show in Denver, CO.

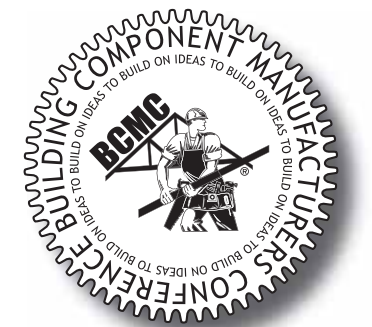

Columns

Editor's Message • Diversifying, Staying Connected Are Key in Current Environment	7
Technical Q&A • Questions about Stress-Graded Lumber	10
Safety Scene • You Are Getting Very, Very Sleepy...	12
WTCA Update • New Guide for Cold-Formed Steel Component Manufacturers	14
The Big Picture • Diversification & Patience...Our Last Resources	16

Departments

Chapter Corner	56
Calendar of Events	60
Advertiser Index	60
New Products	61
Classified Ads	61
Parting Shots	62

LOOK BEFORE YOU LEAP

These companies provide significant sponsorship of the structural building components industry. Many thanks for their ongoing support!

2008 Gold Advertisers

(Appearing in all 9 issues)

A-NU-Prospect*
BCMC*
Clark Industries*
Commercial Machinery Fabricators*
Eagle Metal Products*
Holtec (USA) Corporation*
Hundegger USA LC*
ITW Building Components Group Inc.*
Klaiser Manufacturing Corp.*
The Koskovich Company*
Lakeside Trailer Manufacturing*
MiTek Industries, Inc.*
Monet DeSauw*
MSR Lumber Producers Council*
Open Joist 2000 Inc.*
Panels Plus*
Pratt Industries*
Qualtim, Inc.*
Simpson Strong-Tie Co.*
Southern Pine Council*
Stiles Machinery, Inc.*
Viking – Wall Panel Systems*
Wood Truss Systems, Inc.*
WTCA*

2008 Silver Advertisers

(Appearing in at least 5 issues)

Eide Machinery Sales, Inc.
Finnforest USA*
Pennsylvania Lumbermens Mutual Insurance Co.
SL Laser Systems LP
TCT Manufacturing, Inc.
Triad/Merrick Machine Co.*

2008 Bronze Advertisers

(Appearing in at least 3 issues)

Anthony Forest Products
The Hain Company
JR Herring Enterprises
Manitou North America, Inc.
PFP Technologies
Trim Fit LLC
Turb-O-Web USA, Inc.
Wasserman & Associates, Inc.

*Indicates Charter Advertiser Status • Listing based on contracts received as of 8/13/08.

For more information about our 2008 Program Advertisers or advertising in general, visit the SBC website at www.sbcmag.info or call 608/310-6706.

STRUCTURAL BUILDING
COMPONENTS
THE FUTURE OF FRAMING



Editor's Message

Diversifying, Staying Connected Are Key in Current Environment

by Bob Becht

Reflections on a year like none other.

It goes without saying that this year so far has been more challenging than I ever imagined, and I'm sure many of you are finding yourselves in the same position. However difficult business is, I feel fortunate to have served as WTCA president over the past year. I like to think of the silver lining in our current situation as forcing us to become better, smarter, more innovative businesspeople. The latest predictions from most resources I've checked call for a housing rebound in 2010—later than originally projected. If you're anything like me, these projections are forcing you to think hard about how your business will stay strong. In a word, I believe one of the keys for many of us is diversification. Taking big or small steps toward diversifying our product lines and related services may feel like uncharted territory after a stretch of "boom" years for our industry. I know that for my company, we had several years of taking orders and trying to keep pace with demand. The environment we're in now is much, much different. We've got to get creative, explore new markets and think outside the box.

Kirk Grundahl shares his **Big Picture** on page 16. Getting back to business basics, he says, is one of the most important survival strategies for any business. Among them: connect with customers, differentiate, and market, market, market. He also talks about the importance of staying connected with peers, and a new forum WTCA created is precisely for this purpose. If there's one benefit of your membership in WTCA, it's staying connected and learning from each other.

Another all-too-familiar example of keeping on your toes no matter how hard things get is spotlighted in one of this issue's features. On page 30, read up on what you can expect the next time you get a surprise visit from OSHA—from the inspection itself to reviewing your safety records. There are even examples from CMs who have endured surprise visits to demonstrate some of the things that can happen during an inspection. You might never be able to foresee the future, but with "What to Expect When You're (Not) Expecting...OSHA," your operation will be as prepared as possible.

A couple more thoughts before I pass the gavel to Ben Hershey, our 2009 president:

Many thanks to the suppliers who have continued to support the industry and component manufacturers by advertising in **SBC**. The value of advertisers who have stayed with the industry through the downturn is tremendous. Readers may not be aware that **SBC** is fully supported by advertising dollars. But in addition, **SBC**-derived revenue also enables WTCA to undertake membership activities that otherwise might not get done due to a lack of funding. I encourage all component manufacturers to support these folks that have stuck with **SBC** through the downturn. You can find a list of them on page 6.

One of the best things I think you can do for your business is to come to a place where you can learn more than any other event of the year: BCMC. If you want to keep your finger on the pulse of the industry, and carry out business planning, evaluating and adjusting, there's no better place to do it. Find a list of this year's exhibitors on page 42. There's still time to register! Visit www.bcmcshow.com for complete details.

In closing, I would like to thank the WTCA Executive Committee and the Board of Directors for the pleasure of serving WTCA over the last year. I also thank the entire WTCA membership for their participation in and support of our great association. **SBC**

at a glance

- ❑ In our current business environment, we've got to get creative, explore new markets and consider ways to differentiate.
- ❑ If there's one benefit of your membership in WTCA, it's staying connected and learning from each other.
- ❑ BCMC is the place to keep your finger on the pulse of the industry and make adjustments to your business.

Certification Made Simple



1. Buy a SCORE package subscription.
2. Follow the steps to certification.
3. Save money on programs and dues.

Learn more at
www.sbcindustry.com/score.php



SCORE Achievers	SCORE Leaders	SCORE Elite
Tri-County Truss, Inc. www.tricountytruss.com Burlington, WA	Builders FirstSource/ Bama Truss & Components www.bamatruss.com Shelby, AL	ProBuild Manufacturing www.carterlee.com Indianapolis, IN
True House, Inc. www.truehouse.com Jacksonville, FL	Dakota Craft, Inc. www.dakotacraft.com Rapid City, SD	Shelter Systems Limited www.sheltersystems.com Westminster, MD
Truss Craft www.dakotacraft.com Cheyenne, WY	Lumber Specialties www.lbrspec.com Dyersville, IA	Sun State Components of Nevada, Inc. www.sunstatenv.com North Las Vegas, NV

STRUCTURAL BUILDING COMPONENTS™ THE FUTURE OF FRAMING

Publisher
Truss Publications, Inc.
6300 Enterprise Lane • Suite 200 • Madison, WI 53719
Phone: 608/310-6706 • Fax: 608/271-7006
trusspubs@sbcmag.info • www.sbcmag.info

Editor
Robert Becht
Chambers Truss, Inc. • rbecht@sbcmag.info

Art Director
Melinda Caldwell
608/310-6729 • mcaldwell@sbcmag.info

Managing Editor & Circulation Director
Libby Maurer
608/310-6724 • lmaurer@sbcmag.info

Editorial Assistant & Staff Writer
Emmy Thorson-Hanson
608/310-6702 • ethorson-hanson@sbcmag.info

Editorial Review
Suzi Grundahl
608/310-6710 • sgrundahl@sbcmag.info

Advertising Sales & Marketing
Peggy Pichette
608/310-6723 • ppichette@sbcmag.info

Jan Pauli
608/310-6746 • jpauli@sbcmag.info
Kirk Grundahl
608/274-2345 • kgrundahl@sbcmag.info

Staff Writers for September/October
Molly E. Butz • Ryan J. Dexter, PE. • Anna L. Stamm

Accountant
Mike Younglove
608/310-6714 • myounglove@sbcmag.info

Computer Systems Administrator
Rick Saindon
608/310-6717 • rsaindon@sbcmag.info

Send all ad materials, insertion orders,
contracts & payments to:
Truss Publications, Inc.
6300 Enterprise Lane • Suite 200
Madison, WI 53719
Phone: 608/310-6706 • Fax: 608/271-7006
trusspubs@sbcmag.info • www.sbcmag.info

The mission of *Structural Building Components Magazine (SBC)* is to increase the knowledge of and to promote the common interests of those engaged in manufacturing and distributing structural building components. Further, *SBC* strives to ensure growth, continuity and increased professionalism in our industry, and to be the information conduit by staying abreast of leading-edge issues. *SBC's* editorial focus is geared toward the entire structural building component industry, which includes the membership of WTCA – Representing the Structural Building Components Industry. The opinions expressed in *SBC* are those of the authors and those quoted, and are not necessarily the opinions of Truss Publications or WTCA.

Copyright ©2008 by Truss Publications, Inc. All rights reserved.



**THE ONLY SAW FOR
COMPLETE PRODUCTION***
**PRODUCTION IS MORE THAN JUST QUANTITY; IT ALSO INCLUDES
FLEXIBILITY, SPEED, QUALITY, AND EFFICIENCY.*



- COMPARE OUR PRODUCTION CHECKLIST WITH OTHER SAWS:**
- HIGH END ARCHITECTURAL COMPONENTS
 - SOLID WOOD HEADERS
 - TRUSS PARTS
 - WALL PARTS
 - STAIR PARTS
 - I-JOIST

(435) 654-3028
WWW.HUNDEGGERUSA.COM
WWW.WHOLEHOUSESAW.COM

For reader service, go to www.sbcmag.info/hundegger.htm



A look at stress-graded lumber.

by Ryan J. Dexter, P.E.

Lumber plays such a significant role in the design of metal plate connected wood trusses that it is no surprise that we often receive questions about it. The questions often simply refer to lumber design values; but sometimes the questions reflect the terminology used. We have all heard the term "stress-graded lumber" for example, but what does it mean? The term is used frequently in this industry. For instance, the *Building Component Safety Information (BCSI)* booklet states that the "minimum size of lumber used as lateral restraint and diagonal bracing is 2x4 stress-graded lumber unless other size is specified by the building designer."

Question

Is 2x4 Spruce-Pine Fir #1/#2 considered a stress-graded lumber? After all, it is visually graded in order to determine its structural capabilities, not for its appearance. Or does stress-graded lumber mean machine graded?

Answer

Any lumber that is graded to assign design properties would be considered stress-graded. It makes no difference whether the material is graded visually or mechanically (e.g., Machine Stress Rated [MSR] or Machine Evaluated Lumber [MEL]). Any material with listed design properties in the *National Design Standard for Wood Construction (NDS) Supplement* or in individual lumber use guides are considered stress-graded and are acceptable per the BCSI general requirements. If a product is only graded for appearance (i.e., boards) and design values have not been established for the grade, then that material, although graded, is not stress-graded.

Question

Is there a minimum grade recommended for truss members? Do tension members need to be machine stress rated lumber?

Answer

Truss members can be stud grade as long as the design values are equal to or less than the stresses that are actually going through the truss. And no, the lumber does not need to be machine stress rated, but stress values need to be associated with the lumber. ANSI/TPI 1-2002 Section 3.4.1 states:

Truss lumber shall be the grade and size specified on the truss design drawing. Truss lumber of a different grade shall be permitted to be substituted if the substitute grade does not exceed the coefficient of variation for modulus of elasticity (COVE) of the specified grade, and meets or exceeds the specified grade for each of the following properties:

- (a) allowable design value for bending (F_b);
- (b) allowable design value for tension (F_t);
- (c) allowable design value for compression parallel to grain (F_c);
- (d) allowable design value for compression perpendicular to grain ($F_{c\perp}$);
- (e) allowable design value for shear (F_v);
- (f) allowable design value for bearing (F_d);
- (g) specific gravity (G); and
- (h) average modulus of elasticity (MOE)

Any changes in grade not meeting the above requirements, or any changes to structural composite lumber products shall require the review and approval of a Truss Designer.

As long as the allowable design values of the lumber (which are based on the species and grade) are at least equal to the amount of stress that the lumber will be expected to resist in the truss design, the lumber is acceptable. The only way to know what the allowable stresses are is to use lumber graded by the lumber manufacturer. Typically, truss webs are at least Number 3 or stud grade and chords (whether bottom chords which are typically in tension or top chords which are typically in compression) are at least Number 2 grade.

You should expect to find the same quality lumber in trusses as you would in any other type of construction. The lumber used in trusses is sized and graded the same way all structural lumber is. Lumber species of Southern Pine, Spruce-Pine Fir, Hem-Fir, or Doug-Fir-Larch are common. These lumber species are often used in trusses and are available in structural grades such as Select Structural, No. 1, No. 2, etc. Metal connector plate strength values are tested in the various lumber species that they will be used in; truss design software must contain the species and grade dependent lumber and plate values in order to correctly perform to the truss design.

Ultimately, trusses can be designed with any stress-graded lumber. Depending on the design loads, certain grades of lumber may not be adequate to handle and transfer the given loads for a particular truss design and thus they would be unacceptable. These cases would require a higher grade of lumber to adequately resist the forces in the truss. **SBC**



MASTER PLANK®
BEAMS & HEADERS
STRONG • LIGHTWEIGHT • STABLE



BUILDING A TRADITION OF QUALITY PRODUCTS

- LVL Attractive Beams & Headers
- LVL Structural Stair Stringer Blanks
- LVL Specialty Plywood
- LVL Truss Chords (Alpine™ & MiTek® plate values)
- LVL 3-1/2" One-Piece Garage Door Headers
- LVL Scaffold Plank & Other Industrial Applications



KRB GLULAM®
COLUMNS • WINDOW & DOOR HEADERS

Finnforest USA *Out-performs solid sawn lumber and offers...*

- High strength to depth ratios
- Multiple span capabilities
- Building Code approvals and OSHA compliance

AN EXCELLENT VALUE!

*We produce thousands of products from wood...
The only limit is your imagination.*

finnforest Finnforest USA
Engineered Wood Division

www.finnforestus.com • 800/622-5850 • Fax: 586/296-8773

For reader service, go to www.sbcmag.info/finnforest.htm

at a glance

- Any lumber that is graded to assign design properties is considered stress-graded, no matter if it was visually or mechanically graded.
- Material with design properties listed in the NDS Supplement or in individual lumber use guides is considered stress-graded.

DON'T BUY OUR EQUIPMENT;
If you are satisfied with lower productivity,
higher operational costs,
and producing just satisfactory components.

DON'T BUY OUR EQUIPMENT;
If you are content with
equipment of poor quality,
substandard design,
inferior manufacturing practices and
Unsatisfactory service.



Klaisher manufactures **EQUIPMENT** that will help you
to increase your productivity, decrease your overhead
cost and make better components.

GIVE US A CALL: 317-736-0417

NOW IS THE TIME!
LET US SHOW YOU HOW

For reader service, go to www.sbcmag.info/klaisher.htm



Safety Scene

You Are Getting Very, Very Sleepy...

by Molly E. Butz

Sufficient shut-eye plays an important role in day-to-day safety.



Our schedules are always full. Talk to anyone around you and they have everything from their kids' soccer and softball games to a weekend full of backyard barbecues on their calendar. (And that's not including the extra hours, or even extra shifts, they are putting in at work.) We're spending more and more of our time doing a myriad of activities that don't include the one thing we could all use a little bit more of: sleep.

It's understandable, for certain. Why hit the hay when a new episode of *CSI* is about to start? And seriously, nobody would have passed up those choice tickets to see your favorite band, sports team, etc. Unfortunately, according to the National Sleep Foundation, our busy lives are cutting into the recommended seven to nine hours of sleep each night.¹ So much so that our lack of sleep is affecting our health, job performance and safety! With a limited number of hours in the day, it's important to understand how fatigue and sleep deprivation can affect every aspect of our lives and more importantly, how to squeeze in a few more winks.

In Sickness & in Health

It might surprise you to learn that not getting enough sleep can be the underlying cause in a number of potentially serious health concerns. However, studies have shown a correlation between lack of sleep and illness, from diabetes and heart disease to cancer. Additionally, getting less sleep can lead to weight gain or even obesity. Needless to say, too many sleepless nights might lead to an expanding waistline and an expanding list of health issues.

There are plenty of functions to maintain while we're awake, so it makes sense that our sleeping time is used to regulate and restore many of our body's systems. This down time allows us to feel relaxed and refreshed in the morning, prepared for a new day. Without this restorative time, the body is left to perform at a deficit.

Danger, Danger!

Unfortunately, this deficit can lead to more than medical concerns. If your job is low-risk, say in an office building, the most common effects of fatigue on the job include everything from having a hard time concentrating to a generally lower level of alertness. And although these ailments might seem innocuous enough, poor job performance could lead to all kinds of concerns including job security. Mistakes on bids, truss design drawings or even simple office communications could be a disaster.

At an even bigger risk are folks whose on-the-job tasks require quick reaction time, manual dexterity and/or general alertness. Many positions in manufacturing require workers to use equipment that can become hazardous when being operated by a tired employee. In fact, some of the highest-profile historic disasters are thought to be linked to worker fatigue; think Chernobyl, Exxon Valdez oil spill.² And though it may seem easy to dismiss those major accidents, there are everyday jobs that can pose a threat if you're not getting enough sleep, such as operating a forklift or driving a delivery truck.

As long as we're talking about driving, it's important to point out that whether you're hauling a big load to a jobsite, or you're making your short commute to work, oper-

According to the National Sleep Foundation, research has shown that severely sleep deprived people show "impairment equal to being legally drunk."

ating any vehicle while drowsy is dangerous. The frightening fact is that a lot of us do it! The National Sleep Foundation's 2008 Sleep in America poll showed that 32 percent of the respondents reported that they had driven drowsy at least once per month during the past year.³ Worse yet, more than one-third admitted to nodding off behind the wheel!

Zzzzzzzzzzzzzzzzzzzzz

There are many reasons we aren't getting enough sleep. For some it's stress, others an overly-busy schedule, and for far too many people, one of a number of medical conditions is preventing those precious hours of shut eye. If you think you're one of the latter, see your doctor. Some medical conditions, such as sleep apnea, a prevalent sleeping disorder that causes its sufferers to stop breathing momentarily several times a night, can even be fatal. However, if you're one of many folks that simply have too much on their mind, or too much on their schedule, some simpler techniques can lead to better, longer sleep and easier, more productive days!

- **Analyze:** Take the time to think about the days when you feel the best and determine how much sleep you've gotten the night before. That should give you a good sense for how many hours a night you should get on a regular basis.
- **Plan:** If you know you need eight hours a night, rearrange your schedule and block off those hours for sleep. If it doesn't look like getting eight hours is a possibility, plan to take a nap at some point later in the day to get the rest. Thankfully you don't actually need to get all eight at one time! Keeping a consistent schedule is helpful, too!
- **Exercise:** Regular exercise is a great way to help your body in many ways including falling and staying asleep. Just keep in mind that exercising right before bed can make it harder to fall asleep, so try to finish your workout three hours before you plan to hit the sheets.
- **Diet:** As you may have suspected, foods containing stimulants like caffeine can affect how you sleep so limiting or elimin-

Clark Industries, Inc.
Since 1967—Monett, Missouri

So, your company has invested in...
*Automated Component Saws, Laser Projection Systems,
Automated Jigging Tables,
...and you're STILL manually stacking your trusses?*

CONTACT US TODAY FOR YOUR NEW AUTOMATED HORIZONTAL STACKING SYSTEM!

- Reduces handling labor & liabilities
- Design minimizes wear & maintenance
- Stacks to both sides of conveyor (2, 3, 4, or more stacks)
- No hydraulics - fully electric
- Lower operation costs vs. hydraulic
- Remote control & electronic truss sensing system

Your solution to manual stacking

Call us toll-free @ 1-800-743-9727 or visit our web site @ www.clark-ind.com

For reader service, go to www.sbcmag.info/clark.htm. See additional ad on page 60.

inating them from your diet can help. (It's also best to avoid nicotine in the evening as this can also disrupt your sleep.)

If you're still finding you're sleepy at work, a few more tips can help ease you through your day.

- **Hydrate:** Dehydration and sleeplessness are a bad combination; drink more water if you're feeling tired. Hydrating your body can help fight some of the effects of fatigue.
- **Refocus:** If you find your mind wandering, take a few minutes to get up, walk around a bit or grab a quick snack. If you're tired, getting the blood moving or diverting your thoughts from the task at hand for just a few moments can actually help you focus when you come back to the project.
- **Nap:** If you're lucky enough to work for a company that allows for naps, dig in! If not, ask if you can combine your break times to catch a few winks. Two fifteen minute breaks make a nice half hour nap.

Everybody has a day here or there that requires sacrificing some sleeping time, but making that a habit, whether it's by choice or not, can have grave consequences. As a matter of fact, according to the National Sleep Foundation, research has shown that severely sleep deprived people show "impairment equal to being legally drunk." And no matter how you roll the dice, feeling tired all the time is no fun. So, keep yourself and those around you safe by getting back to bed! Safety first! **SBC**

To pose a question for this column or to learn more about WTCA's Operation Safety Program, contact WTCA Staff at 608/274-4849, email wtca@sbcmag.com, or view the Operation Safety demonstration online at www.wtcatko.com.

¹ www.sleepfoundation.org
² www.nts.gov/PublicIn/1997/MAR9702.pdf
³ www.sleepfoundation.org/site/c.hu1XJMO1xF/b.3933533

at a glance

- ❑ Many of us do not get enough sleep, which can lead to mistakes and poor job performance.
- ❑ Tips for dealing with fatigue at work include hydration, taking a quick break to refocus and napping.



Wtca Update

New Guide for Cold-Formed Steel Component Manufacturers

by WTCA Staff

Announcing the new cold-formed steel version of BCSI.

With residential housing moving at a snail's pace, the commercial and multi-family construction markets have become bright spots for many manufacturers in the industry to make up ground. It couldn't be better timing for a new guide aimed at the safe handling of cold-formed steel (CFS) components.

In July, WTCA's Cold-Formed Steel Council (CFSC) released the *Cold-Formed Steel Building Component Safety Information booklet (CFSBCSI)*, now available for purchase. Modeled after BCSI, it includes the most current information regarding the handling, installation, restraint and bracing of cold-formed steel trusses.

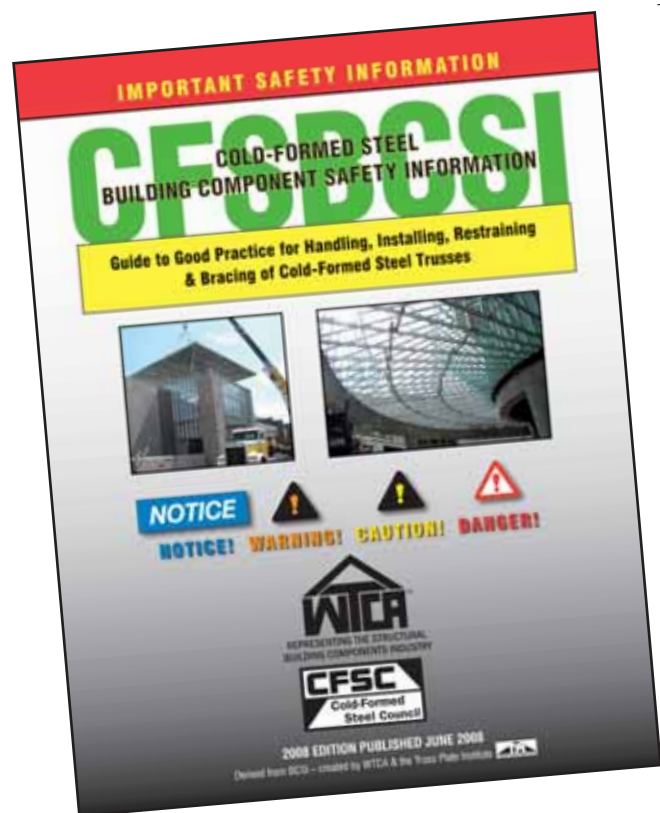

The booklet includes information on important safety items to be considered when handling and installing trusses, required information for building designers to include in the construction documents, crane use and proper truss handling, hip set assembly installation recommendations, long span truss installation, field assembly and other special conditions, permanent restraint and bracing concepts and guidelines, construction loads, truss damage, jobsite modifications and installation errors, and fall protection general guidelines.

A committee of CFSC members collaborated on the booklet over the last year. Mike Noonan of Cascade Mfg Co and CFSC co-chair served on the project committee. He said this type of safety guide has long been needed by CFS manufacturers to educate the people who handle their products. "The CFSBCSI is a great risk management tool for your business, which is why the industry has been asking for it. All truss fabricators who have been involved with steel are in need of this tool, and it hasn't been available before. Now that it is, we as an industry need to make use of it," said Noonan.

Joe Odgers, CFSC co-chair from Builders FirstSource, said that by embracing CFSBCSI, CFS manufacturers can ensure that a unified message about the product is sent to the marketplace. "Before this document existed, we lacked a common message. Now the process of educating building designers, contractors and framers will be a lot easier," he said.

CFSBCSI is available in an easy to read 8½" x 11", spiral bound booklet and includes many photographs and graphics that help clarify and support the handling and erecting practices discussed in the text. In addition, each of the six chapters of CFSBCSI are also available as individual Summary Sheets that are combined into an easy to use JOBSITE PACKAGE. This package condenses the information provided in each chapter into a few pages that emphasize the main concepts using a more graphical presentation for ease of use in the field. **SBC**

To learn more about CFSBCSI or to order copies, visit www.cfsc.sbcindustry.com.

at a glance

- ❑ A new booklet for handling, installing, restraining and bracing of cold-formed steel trusses is now available.
- ❑ CFSBCSI is organized into six chapters, each of which exists separately as a Summary Sheets
- ❑ The CFS JOBSITE PACKAGE is a graphical presentation of CFSBCSI concepts for ease of use in the field.



New WTCA Members

ASSOCIATE MEMBERS
International Beams, Inc.
418 St-Dizier St
Montreal, QC H2Y 3P8
514/849-4849
Mr. Tim Staniszewski

Listing as of 8/7/08.

For more information about WTCA membership, contact Anna (608/345-4983 or astamm@qualtim.com) or visit www.sbcindustry.com.



WTCA Open Quarterly Meeting Friday • October 3 • 5 pm

All are invited to attend the 2008 Open Quarterly Meeting and Top Chord Club Dinner on Friday, October 3 at 5 pm. Meeting, dinner and awards presentation will be held at Panzano located at the Hotel Monaco, 909 - 17th Street at Champa.

- 5 pm: Meeting
- 6 pm: Cocktails and appetizers
- 7 pm: Dinner

For more details & to register, call Stephanie at 608/310-6721.

For reader service, go to www.sbcmag.info/wtca.htm

WTCA Board of Directors

Officers & Executive Committee Reps.

- **President:** Robert J. Becht • Chambers Truss, Inc. • 772/465-2012 • bob@chamberstruss.com
- **President Elect/Treasurer:** Ben Hershey • Alliance TruTrus, LLC • 602/252-1772 • bhershey@trustrus.com
- **Secretary:** Steven Spradlin • Capital Structures Inc. • 479/725-2112 • sspradlin@capstructures.com
- **Past President:** Barry E. Dixon • True House, Inc. dba True Truss • 904/757-7500 • barry@truehouse.com
- **Kenneth M. Cloyd** • California Truss Co. • 951/657-7491 • kenc@caltruss.com
- **Dwight Hikel** • Shelter Systems Limited • 410/876-3900 • dwight@sheltersystems.com
- **Frank B. Klingner** • Mid-Valley Truss & Door Co. • 956/428-7090 • ftcfbk@aol.com
- **Joe Odgers** • Builders FirstSource/Bama Truss & Components, Inc. • 205/669-4188 • joe.odgers@bldr.com

At-Large Representatives

- **Dean DeHoog** • ProBuild North • 616/677-3743
- **Allen Erickson** • Cal-Asia Truss • 925/680-7701
- **David Horne** • Universal Forest Products, Inc. • 336/226-9356
- **John A. Smith** • Foxworth-Galbraith Lumber Co. • 972/437-6100
- **Dave Walstad** • ProBuild East • 856/380-3600

Directors Representing Chapters

- **Phil Adams** • Northwest Building Components, Inc. • 208/687-9490
- **Keith Azlin** • U.S. Components, LLC • 520/882-3709
- **Bruce J. Bain** • Richco Structures • 920/336-9400
- **Clyde R. Bartlett** • Bluegrass Truss Company • 859/255-2481
- **Rick Cashman** • Florida Forest Products • 727/585-2067
- **Mark A. Casp** • ProBuild East • 352/343-0680
- **David A. Denoncourt** • Beau-Trusses • 603/796-2974
- **Jack Dermer** • American Truss Systems, Inc. • 281/442-4584
- **James C. Finkenhoefer** • Truss Systems, Inc. • 770/787-8715
- **Joseph D. Hikel** • Shelter Systems Limited • 410/876-3900
- **John Hogan** • Vivco Components • 816/449-2161
- **Michael Karceski** • Atlas Components, Inc. • 815/332-4904
- **Chris Lambert** • Southeastern Materials, Inc. • 704/983-1144
- **Glenn McClendon** • Sun State Components of Nevada, Inc. • 702/657-1889
- **David Motter, P.E.** • Tri-County Truss, Inc. • 360/757-8500
- **Richard P. Parrino** • Plum Building Systems • 515/327-0698
- **Michael Redmon** • Atlantic Building Components & Services, Inc. • 864/859-9425
- **Mark H. Rose** • Manning Building Supplies • 904/268-8225
- **Timothy Rouch** • Gang-Nail Truss Co., Inc. • 559/651-2121
- **Gary Sartor** • Stone Truss Company, Inc. • 760/967-6171
- **Steven L. Stroder** • ProBuild North • 317/834-5380
- **Terry Tontarski** • Fabco - Tontarski, Inc. • 315/782-5283
- **Scott Ward** • Southern Components, Inc. • 318/687-3330
- **Stephen Yoder** • Stark Truss Co., Inc. • 330/477-6676

Associate Member Directors

- **Steve Cabler, P.E.** • MiTek Industries, Inc. • 314/434-1200
- **Keith Lindemulder** • Nuconsteel Corporation • 940/891-3077
- **Tawn A. Simons** • Simpson Strong-Tie Co. • 925/560-9000
- **Chad Ward** • Temple-Inland Forest Products • 936/829-5511



The Big Picture

Diversification & Patience... Our Last Resources

by Kirk Grundahl, PE.

What you can do to stay productive and positive.

If you ever thought you had control of your business's destiny and that you had enough business savvy to out-think any problem, this is the business cycle that could easily bring you to your knees with humility. The marketplace just does not care if you do well or fail. There are several key lessons here for sure, the most important being that one has absolutely no overall control.

This is the most challenging time most of us have ever faced in business. We feel even more helpless when we're struck with the stark realization that most of what has happened to our businesses, even to the point where we may be forced to go out of business, is not due to fundamentally bad business decisions. What is occurring is a series of forced changes to all facets of our business. One suspects that by now you have no more significant options for cost reductions left, so the business game has to shift to what to do next.

As current WTCA President Bob Becht said in his final article, business diversification is a key word today. We need to be thinking this through. The fundamental question is if and how diversification will make a difference for business in the necessary timeframe. While patience is not easy to have in situations like this, patience coupled with focused, diligent, detailed, hard work may be the only resource that remains for some of us.

While each of our businesses are different in terms of goods and services provided, there are some common themes and concepts that may have value in considering. Here are four that I believe are the most valuable in our current environment.

1. Take a hard look at your sales function.

Challenge your team to communicate more with people who have a good feel for the market. What ideas do your sales staff have regarding the market and where opportunities lie? Attendance at local construction market oriented tradeshows will give you a much better feel for all facets of the local/regional construction markets. If you have not already been involved in your customers' local trade association, it is definitely a good time to do so. If you've been doing this all along, these relationships are likely coming in handy now.

Another approach is to go to the horse's mouth. Communicate more with current customers and ask if there are opportunities to help them. Their responses may initiate a dialog about how you could add value to their business. It is always valuable to speak in depth with your close customers because the things you learn from one can be easily applied to others.

Once you and your sales team has adequately surveyed customers, expand or alter services to meet their needs. This might mean partnering with them to move together into markets they (and you) may not have served before. If they have downsized like you, talk about developing a strategy, with them, to fill the gaps they have in their business with services that fit your staff's skill sets and their immediate needs.

Based on the direct marketplace feedback you gather pick a select few target markets to see what results can be generated and what feedback you gain and then adjust, adjust, adjust.

Continued on page 18

at a glance

- ❑ Making sound business decisions in this business cycle provides no guarantee of business success.
- ❑ We must recast the notion of diversification and find creative new ways to serve customers.
- ❑ Beyond evaluating sales and product lines, defining clear objectives and consulting with industry peers for ideas are important exercises.

DO THE MATH!

SS+TS+IPH=



Superior Strength + Top Stiffness + Ideal Plate Holding = Southern Pine



www.southernpine.com

504/443-4464 • Fax 504/443-6612

For reader service, go to www.sbcmag.info/spc.htm

DISCOVER THE COST SAVINGS when using Southern Pine, offering superior strength, stiffness, and plate-holding ability. The Southern Pine Council's brochure *Southern Pine for Structural Components* details these savings using a direct design comparison between lumber species for a typical project. Request or download your free copy at www.southernpine.com, your source for the latest Southern Pine lumber information.

SOUTHERN PINE: YOUR CHOICE FOR COMPONENTS



PENNSYLVANIA LUMBERMENS MUTUAL
INSURANCE COMPANY

For over 100 years
we've been protecting
businesses just
like yours.

Tomorrow
we'll do
the same.

wood is all we do.

At PLM, we understand that you need an insurance company with property and casualty insurance products and services that you can trust.

For over 100 years, our experts have been providing quality claims and risk management services to the lumber, woodworking and building material industries. Remember, "you get what you pay for." We understand wood. We know your business... because it's our business too.

If you're looking for quality and value from your insurance provider, give us a call.

Yesterday, Today, Tomorrow... grow knowing you're covered.

For more information, please contact the PLM Marketing Department at 800.752.1895 or log on to www.plmins.com.

Pennsylvania Lumbermens Mutual Insurance Company
One Commerce Square
2005 Market Street, Suite 1200
Philadelphia, PA 19103

John Smith

John K. Smith, CPCU
President and Chief Executive Officer

For reader service, go to www.sbcmag.info/plmins.htm

The Big Picture

Continued from page 16

2. Take a hard look at your product lines.

Seriously evaluate what diversification means to your business and how it can be implemented. It may mean getting into washer/dryer sales. I hope it doesn't come to that, but the point of conducting this exercise is to identify the low-hanging fruit that can generate cash now and allow you to build business in an alternative direction(s).

I'll be more specific. It might mean determining the areas of your business in which you out-perform the competition and seeing how those areas can be put together with a changed

or new series of product lines that will provide unique value in the marketplace. Alternatively, it could mean expanding more deeply into the residential and commercial/industrial structural framing marketplace to provide the full array of building material services including red iron, concrete, or any of a wide variety of complementary materials. Add more building materials to sell along with any unique services you can think of that will set you apart.

What product line or combination of product lines can you add in your market area that others cannot get easily and that would provide you with a unique offering? What about framing or building design? What about teaming up with a builder, framer and building designer to collaborate on projects and truly implement optimum value engineering concepts?

This is clearly not the kind of market that allows you to rule out options or be too picky about what you are going to be doing, so the goal will be to foster as much creativity as possible when brainstorming.

3. Develop clear goals, objectives & benchmarks.

Lay out realistic yet challenging goals and objectives that align well with the skill sets of your staff and the framework of your business. Focus on your strengths and the things that make you unique, and make sure that the unique features and benefits are present in your goals. Learning how to exploit this uniqueness will serve you well no matter what kind of business environment you are presented with now and in the future.

Next, monitor sales and marketplace feedback daily. Do not be afraid to abandon

objectives that are not working and quickly adjust the goals and plan. Dead ends, frustrating experiences and fluid adjustments will probably be the norm. Do your best to stay as positive as you can, and do not relent.

4. Tap your industry support group.

There is no better time to have a support group of non-competing friends in the industry to bounce ideas off of. This same support group also includes all of your suppliers. Every conversation and meeting presents the ability to learn, evaluate and adjust your current plan. Certainly there is an opportunity or idea that can come out of every exchange. It's up to each of us to look for it and capture the vision on how to take advantage of it.

Continued on page 20

Learn from Your Peers at BCMC

There is only one place you can go to meet with the largest gathering of you peers that exists in our industry: BCMC. If you want to know more about your industry or business in general, you can learn a lot from your fellow agents in the field, said writer Geoff Williams in a recent Entrepreneur.com article. Williams quotes a British entrepreneur Douglas de Jager who joined a networking organization to grow his online property search site.

"Your peers are your best resource," said de Jager. "It was a way for members to share experiences and to learn from each other. It's amazing what ideas can come from a collective group."

Coming to BCMC provides a similar experience in peer-to-peer interaction. For instance, on Tuesday of BCMC week, component manufacturers are invited to attend a four-hour roundtable titled "Planning, Evaluating and Adjusting—Your Business Lifeline." Here you will have the opportunity to compare strategies, track benchmarks and discuss industry financial performance data with other component manufacturers.

When the roundtable is over, you've got the exhibits to look forward to. Compare notes on equipment, software and services with other attendees on the show floor. Spend some time making connections with newcomers and industry veterans. In the end, you can use these different interactions to improve your

own company in big and small ways—evaluate your current operation, analyze your markets and adjust for changes that can be made. Every new idea you take away from BCMC has the potential to make a difference in your success.

Find your own business group at BCMC, and tap your best resource to improve your operation. You've got nothing to lose! For more information about this year's show, see pages 41-51, review the enclosed attendee promo, or visit the BCMC website and register online at www.bcmshow.com.

"In a down turn is when you need BCMC the most. The networking you can do with other component manufacturers and the educational sessions are invaluable. You can also use this time to talk to other manufacturers on how they are handling the down turn in their market and with this information you will get great ideas that you can take back to your operation and implement. I think BCMC is one of the most important events that you can attend during a down turn in the economy. Cancel every other tradeshow that you attend but don't miss BCMC!!!!!!"

—Don Groom (2006 WTCA President),
Stark Truss Co., Inc., Canton, OH

TCT Manufacturing Inc. - PO Box 1659 Sorrento, FL 32776 - 352-735-5070 - www.tctautomation.com

Real Automation For
Component Manufacturers
Right Now



Bobby Pool - ProBuild Plant Manager



"ProBuild partnered with TCT based on their leadership position in truss robotics. Their innovative approach to solving our automation needs promises a whole new level of efficiency for ProBuild's manufacturing process."

For reader service, go to www.sbcmag.info/tct.htm



See the light and speed up productivity

Set up your jiggging at the speed of light

- Job file batching → controlled work flow
- Detailed reporting → daily labor evaluation
- Simplified building → reduced labor training
- Increased accuracy → fewer call backs
- Reduced setup times → increased production
- Exact plate placement → TPI conformance

See immediate gains in profit-producing performance

www.sl-laser.com



SL-LASER Systems 8325-J Arrowridge Blvd., Charlotte, NC 28273
Phone: 704-561-9990 Fax: 704-561-9994

For reader service, go to www.sbcmag.info/sl-laser.htm

The Big Picture

Continued from page 18

Closing Thoughts

There are no easy answers in any of this; much of your ability to stay in business in this environment is based on how much cash you have in the bank and how willing your banks are to support you through this rough patch. Our hope and prayer is that you all have a great support system that has come along side you when you are in a particularly challenging situation. Let's not lose faith. Here's to positive hope for our collective future. **SBC**

Wondering how you can stay connected these days? SBC Connection is an online forum for networking, sharing information and discussing current issues. And it's free—all you need is a phone line and an Internet connection! Visit www.sbcindustry.com for the next scheduled SBC Connection.



- Strongest Truss Trailer
- 130,000 PSI Steel
- One Piece Beam
- Lifetime Warranty
- Many Galvanized Parts
- Bigger Rollers

For pricing & ordering information feel free to contact us at:

PRATT Industries, Inc.

2979 W. Bay Drive, Belleair Bluffs, FL 33770
Phone: (727) 584-1414 • Fax: (727) 584-2323
E-mail: sales@prattinc.com

www.prattinc.com

For reader service, go to www.sbcmag.info/pratt.htm



You Don't Need a Crystal Ball to Predict Your Lumber's Design Value

Machine Stress Rated Lumber Has the Strength Stamped on Every Piece

Join the other building professionals who will specify over a billion board feet of MSR lumber this year. Contact us for more information.



P.O. Box 6402, Helena, MT 59604
Phone: (888) 848-5339 • Fax: (888) 212-5110
e-mail: msrlpc@msrlumber.org
web page: msrlumber.org

For reader service, go to www.sbcmag.info/msrlpc.htm



Better trusses in less time
That's the Quik Drive® advantage

Combine the holding power of screws with the speed of the Quik Drive auto-feed screw driving system for an ideal multi-ply truss fastening solution. Using screws to fasten truss plies together allows you to virtually eliminate gaps, resulting in a better finished product. And since the Quik Drive system features collated screws and our patented auto-feed mechanism, your crews can continue to work as fast as ever while potentially reducing injuries when compared to nail gun users. Now doing the job better doesn't have to take more time.

For more information visit us at www.strongtie.com or call (800) 999-5099.

"We're really happy with the Quik Drive system. Our number one focus is quality and I really like the fact that we are turning out a better product. We don't have to worry about gaps between the plies and we're also able to fasten three-ply girders without flipping them over which saves a lot of time. The safety factor is another important benefit since we haven't had any injuries with the Quik Drive tools."

— Jerry Dunsmore, General Manager, Truss Plant, Tindell's Inc.



For reader service, go to www.sbcmag.info/simpson.htm

Commercial Machinery Fabricators, Inc.



The Leader in Heavy Duty Truss Equipment

Edward Joseph president and owner of Commercial Machinery Fabricators, Inc. has been manufacturing machinery for over 25 years. His vision for change in this industry has enhanced the engineering of **THE STEALTH** equipment. Our facility is now manufacturing 100% of its truss tables for planx ready systems. With the current state of our economy it's never been so important for the building industry to move toward automation.

Customer service at its best

Whether your company is a new start up or well established; the owner Edward Joseph services each customer personally. We pay special attention to your facilities layout and your individual production needs. We are considerate of customers concerns and their best interests while also keeping prices competitive. Commercial Machinery Fabricators is a unique company; as a family owned business we are still independent and can provide a personal and business relationship.

Finish Press



Roof Truss Stacker



36" Gantry on Crane Rail



24" Trackless Gantry



Commercial Machinery Fabricators, Inc.

Beyond the customers expectation

We know the importance of meeting your scheduled start up dates and deadlines. We can provide customer service throughout your production years with **THE STEALTH** truss equipment. Several of our machines are still in production after more than 20 years of service. The durability of such machines proves the reliability that Commercial Machinery Fabricators provides its customers.

Contributing to your needs

In today's market in order to succeed it is imperative for a company to obtain a competitive advantage. By improving your company's core strengths you can achieve that advantage. Using **THE STEALTH** equipment can help you reduce lead time making it possible to produce your products more efficiently. Upgrading or purchasing new equipment from Commercial Machinery Fabricators will bring your equipment up to 2008 standards.

Full Service Provider

- 14' or 16' x 24" Diameter Roller Press
- 14' x 24" or 36" Diameter Roller Press
- Truss line systems based upon facility lengths & requirements
- Planx ready truss tables with filler plates for future automation purchases
- Trackless floor truss 42' standard
- Trackless speed line made to customer specifications
- Reconditioned truss equipment available
- Roof & floor truss stackers
- Lumber Carts
- Laser Systems
- Saws
- Automatic jiggging system

24" Gantry on Crane Rail



42' Floor Truss



For more information call us toll-free at:
1-800-662-2857
or visit us at www.cmfstealth.com

16775 Industrial Parkway
Lansing, MI 48906
(517) 323-1996 Fax (517) 327-3451
E-mail: autocad@cmfstealth.com



Church Add-On Gets Beautiful New Chapel with Components

by Joe Heinsman, PE.

The design of a new chapel showcases innovative use of components.

at a glance

- ❑ Stock Building Supply helped to design and build a showy chapel addition.
- ❑ The use of components became interesting when the structural engineer decided that the significant horizontal deflection inherent in steep pitched scissors trusses would be greater than what would be acceptable for this structure.
- ❑ The height of the trusses required that they be built in halves and field assembled.

An addition onto the Toney Chapel to Southport Presbyterian Church in Southport, IN was a unique use of trusses with a number of interesting structural features. While simple in concept and plan, the number of creative approaches needed to construct this “simple” building presented some interesting challenges. The trusses were designed and supplied by Stock Building Supply in Franklin, IN (Davidson Lumber Co. at the time of construction).

The basic plan of the chapel is a cross shape with each of the legs being 40' wide. The legs are relatively short compared to their width. The two side legs are 14'-8" long and the front and back legs are about half of that. There is a gable at the end of each leg. Four intersecting vaults meeting at a point at the center of the building with a high ceiling pitch that was designed for aesthetic effect. The roof was designed at a 12/12 pitch and the ceiling an 8/12 pitch. The walls were designed to be 14' tall.

The use of structural components became interesting when the structural engineer, Scott Jones of Arsee Engineers, decided that the significant horizontal deflection inherent in the 40' steep pitched scissors trusses would be greater than what would be acceptable for this structure. In addition, the height of the trusses required that they be built in halves and field assembled. His solution was to have the scissors trusses designed similar to three hinged arches and design the exterior walls to

Continued on page 26

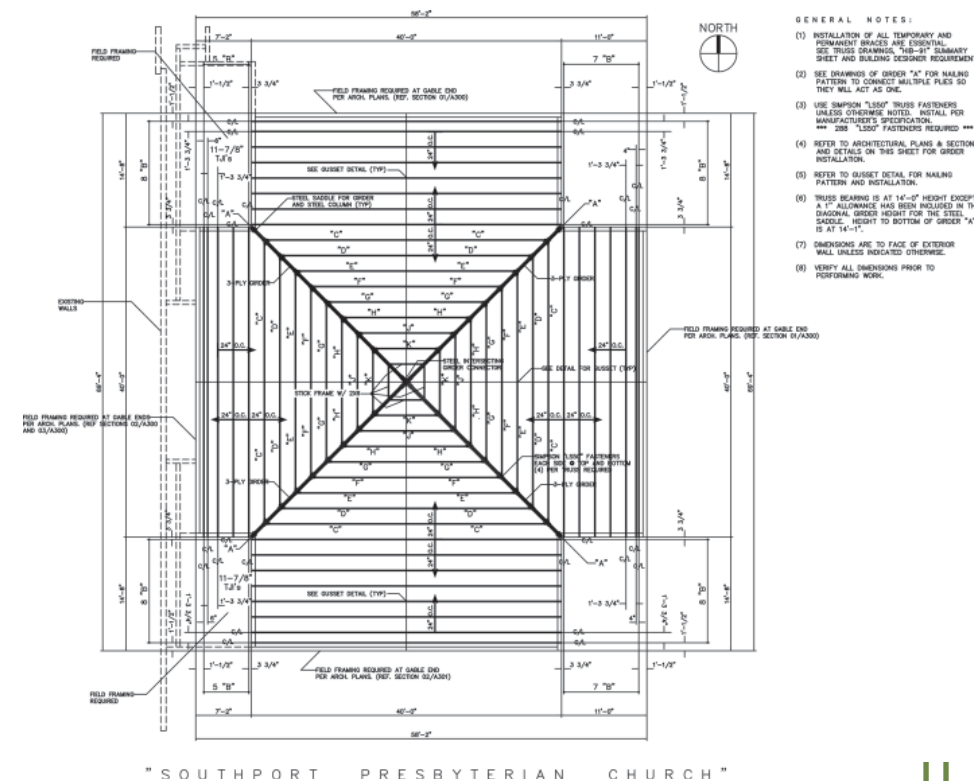

Figure 1. The design drawing indicates four intersecting vaults meeting at a point at the center of the building with a high ceiling pitch. The roof was designed at a 12/12 pitch and the ceiling an 8/12 pitch.

Photo 1. After the steep half scissors trusses were assembled on the jobsite, the trusses for each of the four legs of the addition were set by crane. Steel beams along the top of the walls of each leg and glulam beams in each of the four gables resist horizontal and vertical forces.



Nail the opportunity to build your wall panel business.

Help your builders save critical time and money. With Panels Plus® you'll build wall panels that build sales. Simple, reliable equipment - choices to fit your market:

- **All-In-One Table - frame and sheathe** (full production features in a compact single-table system)
- **Multi-Station Production Lines** (ideal for production builders)
- **Customized Production Lines** (custom lengths to fit your unique needs)

With Panels Plus equipment, you can become your customers' one-stop source for components - and help them survive in today's tight markets.

NEW
Subcomponent Nailer
See it at
BCMC '08 Show
Denver



PANELS PLUS®
Wall Framing Made Simple

sales@panplus.com / www.panplus.com
Toll Free 866.726.7587

For reader service, go to www.sbcmag.info/panelsplus.htm



Photo 2. For aesthetic purposes, the glulam beams are all exposed on the inside of the finished structure

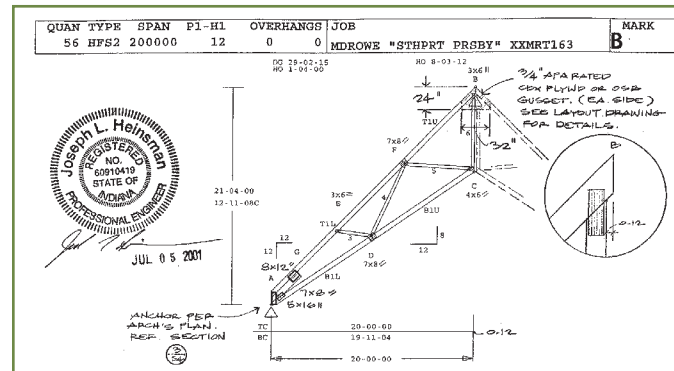

Figure 2.

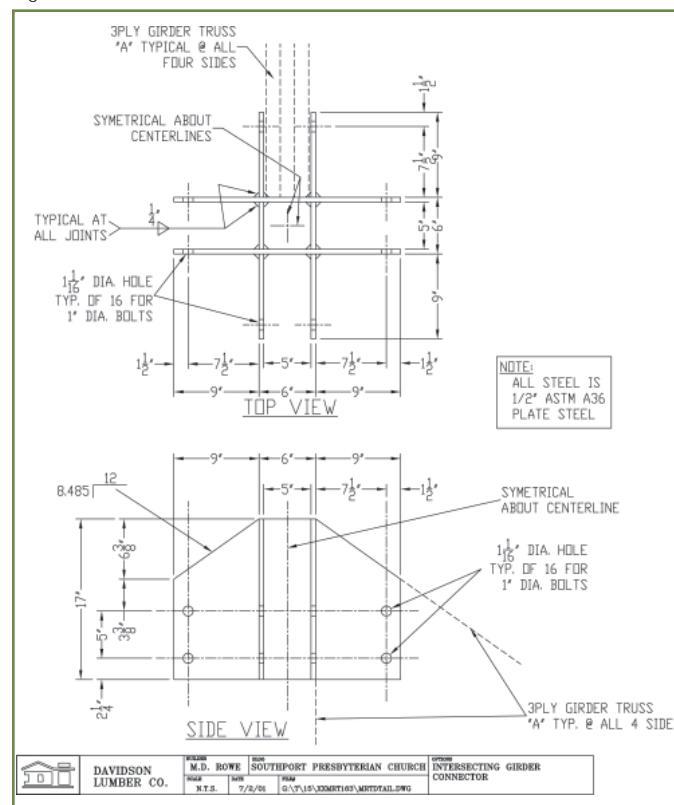

Figure 3.

The trusses were designed and built as half scissors trusses leaning on each other with the only connection at the peak between the top chords using a plywood gusset and nails (see Figure 2). A light connection was made between the bottom chords for stability during erection. Four 3-ply half scissors girder trusses starting from the four inside corners extended to the center point of the building and were also designed similar to 3-hinged arches. These girder trusses leaned against a center compression ring at their peak which was designed and supplied by Stock Building Supply (see Figure 3). The compression ring was of 1/2" plate steel with flange extending down each side of each of the four girders. Two 1" diameter thru-bolts were used at each girder truss. Again the connection was at the top chord only. Stubbed trusses ran

Continued on page 28

Church Add-on...
Continued from page 24

resist the horizontal thrust that resulted. A combination of steel in the side walls of each leg of the chapel and glulam beams in the gables was used to resist the horizontal forces. The steel in the side walls was a wide flange beam along the top of the wall to carry the vertical load with a flat-side-up C-channel on top of it to resist the horizontal thrust of the trusses. Horizontal steel saddles with bolt holes were welded to the top of the C-channel at each truss location. At the inside corners the horizontal load was transferred into the intersecting perpendicular wall's steel framing where it was resisted by either an angled tube steel brace within that wall or steel truss frames that were used in the two walls with openings in them that were too close to the corners to allow the use of the angled braces. At the gable ends, to resist the outward horizontal thrust of the trusses, a horizontal glulam beam ran across the gable end at the top of the walls tying the ends of the walls on either side of the gable together. This glulam was interrupted by two vertical glulam columns. Continuity of the horizontal glulam was achieved by attaching steel brackets to the vertical columns and horizontal glulam at their intersections. These beams, both horizontal and vertical, also served to create a frame to support the large gable wall framing. For aesthetic purposes, the glulam beams are all exposed on the inside of the finished structure (see Photo 2 above).

Think Opportunity. Think Steel.

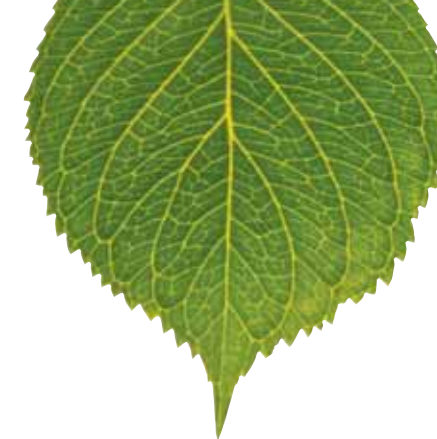

- Slit Coils
High Strength, Galvanized Slit Steel Coil Program
- Plant Layout
Plant Layout and Outfitting Assistance
- NUPRODUCTS
Pre-architected & Pre-engineered Product Lines
- Marketing Support
Innovative Marketing Support
- Training
Comprehensive Training
- Roll Forming Equipment
Low Cost Automated Roll Forming Equipment
- Software
Powerful Panel and Truss Software

Join our Automated Framing Systems Network for a "Total Solution" business package from design to finished products.

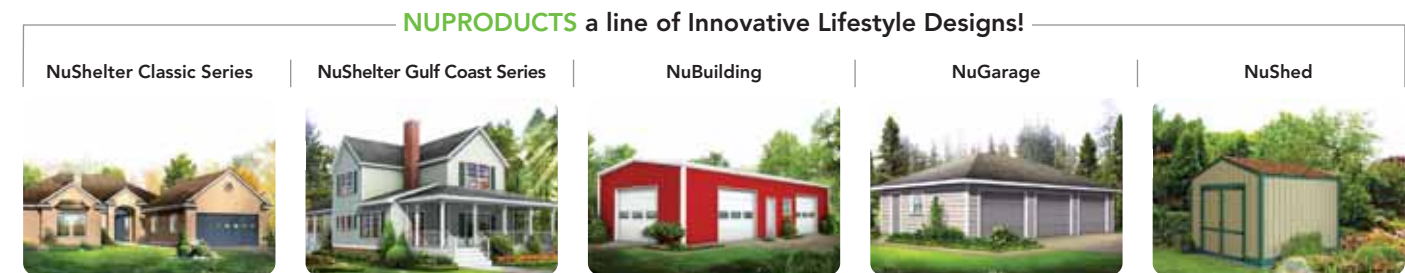

Become part of our Nuconsteel Automated Framing Systems Network. Call 1.866.873.4832 or visit nuconsteel.com today.

NUCONSTEEL
A NUCOR COMPANY

Nuconsteel, NuBuilding, NuShelter, NuGarage and NuShed are registered trademarks of Nuconsteel Corporation. Illustrations are artist's concept only. E.&O.E. 2008.

For reader service, go to www.sbcmag.info/nuconsteel.htm. See additional ad on pages 54-55.

John Griffith

Turb-O-Web USA, Inc.

Daytona Beach, Florida

Office 888 887 2693

Email: john@turb-o-web.com

www.turb-o-web.com

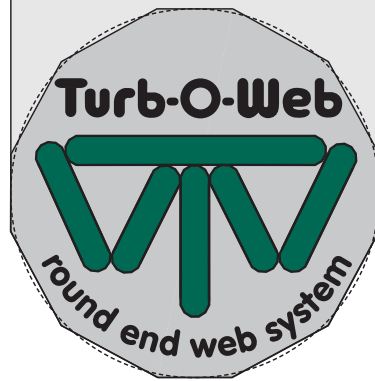

Patented in the U.S. and Canada

For reader service, go to www.sbcmag.info/turb-o-web.htm

New OMGA Manual Finger Jointing Line \$44,225

Includes:

- Shaper, Hydraulic Press & Glue System
- 10' capacity
- 8,000 lf per shift
- Installation
- Add \$2,417 for 14' capacity



800/382-0329 phone • 402/438-2524 fax
www.wasserman-associates.com

Not Comfortable with Used Equipment?

Please consider the following:

- Satisfaction Guaranteed—if it's not right, we'll buy it back!
- Installation Services Available
- Leasing Available
- Shipping Coordination Is Included

Please contact us to sell your excess equipment!

For reader service, go to www.sbcmag.info/wasserman.htm

Church Add-on...

Continued from page 26

between the girder trusses progressing toward the center of the building. Only the shorter of these were not also hinged at their peak. All webs in the trusses had to be aligned because of the need to pass a number of large ducts through the trusses and spread them out throughout the four legs of the building. Since all the trusses were the same basic profile, a stub of that basic profile, or as in the case of the girders—an elongated version of that basic profile, the task of aligning the webs was easily accomplished. The panel nearest the peak was the largest opening and was where all the ductwork was located. The area nearest the center of the roof was stick framed between the girders because the end verticals of stubbed trusses in this area would have interfered with the passage of the ducts. The large horizontal reaction of the girder trusses combined with the horizontal load that was brought to the inside corners by the steel C-channels on top of the walls resulted in a very large overturning load at these corners. As a result, the vertical steel columns that the girders rest on are in tension and a large concrete footing was needed at the base of the column to create the dead weight necessary to hold the column down.

After discussing various options with the project engineer, the decision was made to avoid expensive special order connectors to attach the stubbed trusses to the girders. Instead, the trusses were supported on a sloping 2x6 ledger nailed to the 2x12 top chord of the girders and dropped far enough to allow for a top chord bearing detail. This resulted in double miter cuts on the ends of the top chords with one miter cut against the face of the girder and one miter cut against the top of the ledger. The bottom chords were also mitered against the face of the girder truss (see Figure 4). To keep the trusses from sliding down the ledger, mitered blocking was added between the trusses. The blocking was nailed to the girders with a thru bolt added to keep it from being pried off the face of the girder by the truss it held in place. A standard framing connector was also used from the top of the girder to the top chord of each stubbed truss to keep the truss from sliding away from the girder and off the ledger (see Figure 5). All of this required careful coordination between Stock Building Supply and the project engineer.

The end result was a beautiful chapel which the parishioners of Southport Presbyterian Church have been able to enjoy since it was completed in 2002.

According to Dan Plummer, Director of Environmental Services with Southport Presbyterian Church, they have had no problem at all with drywall cracking or any other movement-related problems. **SBC**

Joe Heinsman is a Professional Engineer and is the Technical Services Manager at Stock Building Supply in Franklin, IN. He has 23 years of experience in the industry.

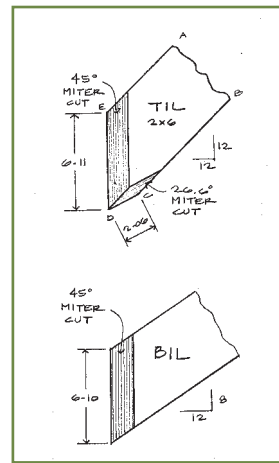

Figure 4.

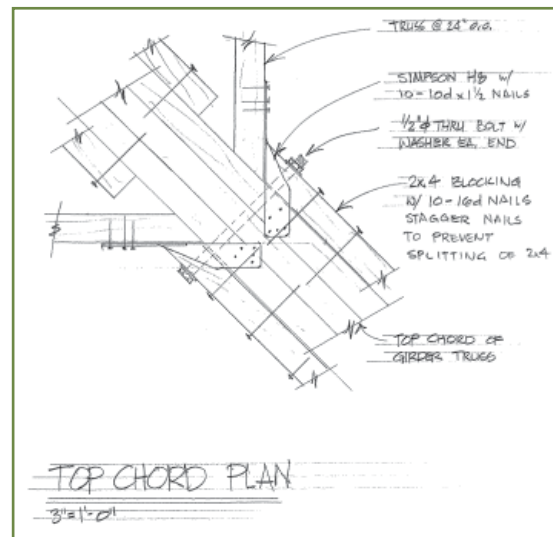

Figure 5. Detail courtesy of Scott Jones, Arsee Engineers, Inc.

WORKS TOGETHER SEAMLESSLY

EVEN WHEN YOU BUY IT ONE PIECE AT A TIME



MISER W/MANUAL FEED DECK

MISER AUTOMATED WOOD PROCESSING SYSTEM
Cuts 350 to 400 truss and wall frame parts per hour. Choose from 4 models and a host of features.



MAGAZINE AND BULK FEEDERS
Picks and feeds lumber into the Miser. Together the machines (not the operator) control the speed of production.



CDS - COMPONENT DELIVERY SYSTEM™
Custom designed to fit your location. Delivers a continuous flow of cut & marked components to your build tables.



PLANX AUTOMATED JIGGING SYSTEM
Sets jiggling pucks in 30 seconds or less, so crews can go straight to building trusses faster. Setup time now becomes "build" time.-

You won't find anything more labor-saving. Nor will you find anything easier to buy. Because you don't have to purchase this automated system all at once. You can add the elements one by one, as your budget and volume require. And all the pieces will work together seamlessly because they're all driven by the same software instructions.

It starts with the **MISER Automated Saw**, which cuts and marks an amazing 350 to 400 pieces per hour. Need more crew to keep up with this? Just add the automated **Material Picking and Feeding System** — now you only need one operator. Add the custom-designed-for-your-plant **CDS - Component Delivery System** to reduce in-house labor and eliminate part tracking. Add the **PLANX Automated Jigging System** and now you've cut your assembly labor costs in half — and doubled your truss output.

You can buy it all at once - or piece by piece. Either way, you'll be purchasing the most labor-saving and profitable system on the market today. All your purchases will integrate seamlessly into this whole plant system. And you can use MiTek's 0% Plus Financing and the tax advantages of the 2008 Economic Stimulus Act to buy it one piece at a time. You couldn't ask for a more seamless path to plant profitability.



For more information:
www.KoskovichCompany.com



Automation that works.™

Miser • Servo Omni • Material Handling • CDS System • PLANX • AGS System

For reader service, go to www.sbcmag.info/koskovich.htm

What to Expect When You're (Not) Expecting...

OSHA

Know what to expect when OSHA surprises you.

by Molly E. Butz

In a perfect world there would be a precise and understandable process for everything, from having a baby to going through an OSHA inspection. And although the title of this article indicates that you might be "expecting" OSHA to stop in, it's not likely they'll give you any warning if they're headed your way. Realistically, unless there's something really major (and unusual) going on at your component manufacturing facility, you probably won't have OSHA knocking on your door. That being said, there are still plenty of reasons an OSHA inspector can and will end up on your doorstep without warning. And, although some states oversee their own (approved) safety/health plans (see Figure 1), those state plans are also required to maintain inspection procedures that are "comparable" to the federal standards. (However, CMs operating in state plan states are not subject to federal OSHA inspections in addition to state inspections.) Let's face it—with all these factors, it's best to be prepared.

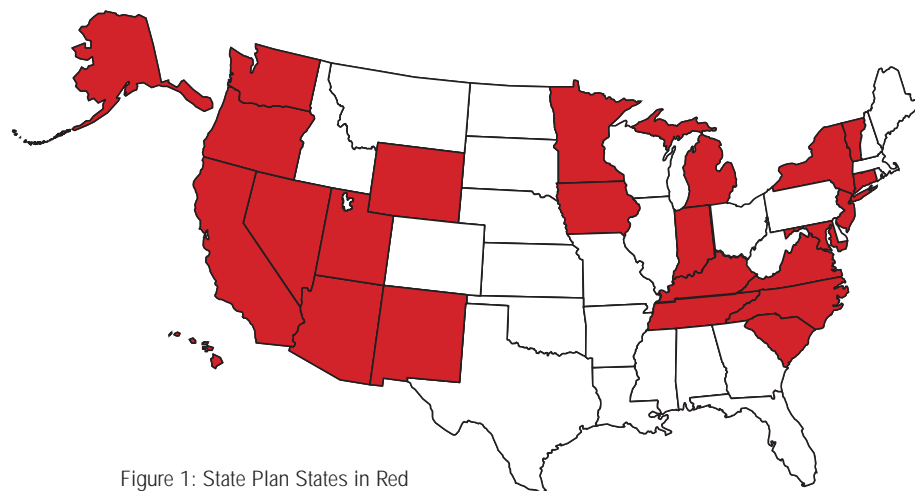

Figure 1: State Plan States in Red

You'll notice as we walk through the OSHA inspection process that some of the language (in quotes) has been taken directly from OSHA's 2008 publication *OSHA Inspections*. This has been done to highlight the specific words and phrases OSHA uses to define the inspection process.

at a glance

- ❑ The most likely causes for OSHA to drop in are an employee complaint or a programmed inspection.
- ❑ Something you can do now is to identify authorized employer and employee reps who would accompany an inspector during a walkthrough.
- ❑ Define an internal safety reporting system to ensure employees are comfortable talking about safety concerns.

Knock, Knock

If there ever is a reason for OSHA to drop in there are a few things you should know. First, the most likely causes for an inspection are an employee complaint or a programmed inspection (see sidebar on page 31). Most importantly, as mentioned before, be aware that the inspection will almost certainly occur "without advance notice." You should also know that before an OSHA compliance officer comes knocking, he or she will review the information about your facility including your "inspection history, the nature of the business, and the particular [OSHA standards] that might apply." It's crucial that you're familiar with these standards, too. After all, you can imagine what kind of impression you'll give if you have to admit you are unaware of the standards with which your business is expected to comply.

OSHA Inspections

With millions of workplaces under OSHA's watchful eye every year, inspections are conducted in order of importance. Established by OSHA, this order is as follows:

- **Imminent Danger:** "Reasonable certainty that danger exists and can be expected to cause death or serious physical harm."
- **Catastrophes/Fatal Accidents:** In this case, catastrophe is defined as "accidents resulting in the death or hospitalization of three or more employees."
- **Complaints/Referrals:** Formal employee complaints of unsafe or unhealthful working conditions and referrals from any source about a workplace hazard.
- **Programmed Inspections:** Aimed at high-hazard industries, workplaces or occupations and are often based on high injury incidents rates.
- **Follow-Up Inspections:** To determine if an employer has appropriately corrected previously cited violations.

However, if you're wondering specifically what might bring OSHA calling, here is a good example. Best Homes, Inc. had a visit from a federal OSHA compliance officer in March 2007. Scott Arquilla, Best Homes' Vice President, indicated that his facility was targeted because their 2005 DART (Days Away/Restricted or Transfer) and DAFWII (Days Away from Work Injury and Illness) rates were higher than the industry average. Falling into the "Programmed Inspections" category (see above), Best Homes' inspection was initiated under OSHA's Site Specific Targeting 2006 (SST-06) Plan which focused on worksites with high DART and DAFWII rates. It's interesting to note that as part of the officer's inspection, she reviewed the company's *significantly* lower DART and DAFWII rates for 2006, but nevertheless proceeded with an inspection of the facility.

Start the Process

An OSHA compliance officer will present his or her credentials upon arriving at your facility. **Always ask to see the officer's credentials and follow up with a call to your state or federal OSHA office to confirm if you have any concerns.** Once you've established the officer's authenticity, he or she will ask to begin with an "opening conference." Clearly you'll want all of the key members of your management team available before this conference begins so make sure that all of your staff, especially your front office folks, knows who to get in touch with



Developed with a powerful design engine and created with a simplified user interface, **TrueBuild®** structural component software is setting a high standard in component design.

Engineered. Tested. True.®

www.eaglemetal.com • 1-800-521-3245

For reader service, go to www.sbcmag.info/eagle.htm

in case a compliance officer arrives. OSHA protocol allows a 'reasonable' amount of time to gather your people; plan on roughly one hour. Note that you can turn the officer away requiring he or she return with a search warrant, but it's hard to believe that such a request will be well received and rest assured the officer will get one and come back. No matter how you choose to proceed, always maintain a respectful, professional manner.

During the opening conference you will learn why your business was chosen for an inspection, the "scope of the inspection," and which OSHA standards will apply during the walkthrough. Depending on the reason for the visit, the inspection may or may not be limited to a specific area of your facility. In addition, the officer will ask you to select both

Continued on page 34

Build Something Strong. Build Something Great.

Great companies are built on solid foundations. They develop insight. They choose strategies.

Great companies find business partners that understand their needs. The Alpine Truswal marks are a guarantee that your trusses are the best in the industry - backed by comprehensive testing and visionary software. You can rely on our engineering integrity and unsurpassed customer service to handle all of the details - so you can focus on what's really important - growing your business.



Call us.
Together, let's build something strong.
Let's build something great.



Alpine Truswal
800-521-9790
www.itwbcg.com

Hardware and Software Tools for Growth

e-SHOP, real-time truss plant management tools.



- Manage costs with better information
- Increase productivity
- Track your people, equipment, lumber and material more efficiently
- Have accurate material inventory and projections -- at your fingertips, instantly!
- Customize production, inventory and manpower reports



Now, the ALS takes a quantum leap into the future.

- Inkjet printing is now on the in-feed side, eliminating manual labeling and printing
- Waste material is fed to the back of the saw; small parts delivered to the front
- Blade motor horsepower increased
- Feed speed is nearly doubled

Alpine Linear Saw

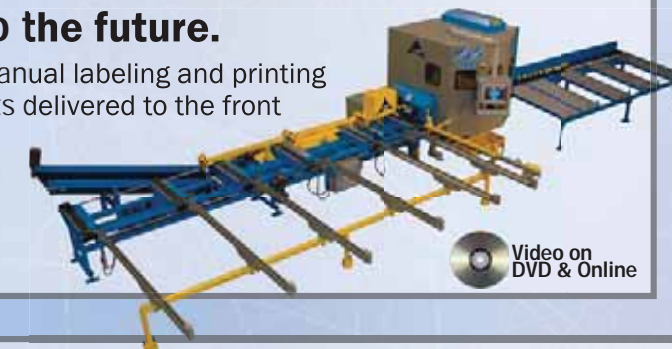

AutoMill HP - High Performance from the industry's most productive and accurate component saw.



- User friendly
- Low Maintenance
- Computer controlled security – no limit switches
- Set up time less than 12 seconds; Average set up time 4 to 5 seconds!

AutoMill HP

AutoSet C4 - the automated truss assembly solution.

- Set up in 30 seconds – or less!
- Build a new truss every 3 minutes
- Increased speed and productivity
- Lower costs with True Servo Technology

AutoSet C4



See us at BCMC!
Oct. 1-3 - Denver, CO

EQUIPMENT
A Division of ITW Building Components Group Inc.

800-755-6005 • www.alpineequip.com



ITW Building Components Group Inc.

OSHA Citations

[Source: OSHA's 2008 publication *OSHA Inspections – Penalties*]

- **Other-Than-Serious Violation:** A violation that has a direct relationship to job safety and health, but probably would not cause death or serious physical harm. OSHA may assess a penalty from \$0 to \$1,000 for each violation. The agency may adjust a penalty for an other-than-serious violation downward by as much as 95 percent, depending on the employer's good faith (demonstrated efforts to comply with the Occupational Safety and Health Act of 1970), history of previous violations, and size of business.
- **Serious Violation:** A violation where there is a substantial probability that death or serious physical harm could result. OSHA assesses the penalty for a serious violation from \$1,500 to \$7,000 depending on the gravity of the violation. OSHA may adjust a penalty for a serious violation downward based on the employer's good faith, history of previous violations, and size of business.
- **Willful Violation:** A violation that the employer intentionally and knowingly commits. The employer is aware that a hazardous condition exists, knows that the condition violates a standard or other obligation of the Act, and makes no reasonable effort to eliminate it. OSHA may propose penalties of up to \$70,000 for each willful violation. The minimum willful penalty is \$5,000. An employer who is convicted in a criminal proceeding of a willful violation of a standard that has resulted in the death of an employee may be fined up to \$250,000 (or \$500,000 if the employer is a corporation) or imprisoned up to six months, or both. A second conviction doubles the possible term of imprisonment.
- **Repeated Violation:** A violation of any standard, regulation, rule, or order where, upon reinspection, a substantially similar violation is found and the original citation has become a final order. Violations can bring a fine of up to \$70,000 for each such violation within the previous 3 years. To calculate repeated violations, OSHA adjusts the initial penalty for the size and then multiplies by a factor of 2, 5, or 10 depending on the size of the business.
- **Failure-to-Abate:** Failure to correct a prior violation may bring a civil penalty of up to \$7,000 for each day that the violation continues beyond the prescribed abatement date.

What to Expect...

Continued from page 31

an "authorized employer representative" and an "authorized employee representative" to be present at the opening conference and subsequent walkthrough. These representatives can be virtually anyone that works at your company, from managers to members from your safety committee. Simply choose folks that you feel fairly represent your company and your employees. And, if you designate your representatives today it's one more easy way to be prepared that you can check off your list!

In early 2007, another Midwest component manufacturer was visited by OSHA after complications following a minor workplace injury resulted in the employee's death. Further review of the circumstances surrounding the injury and subsequent death led the case experts and various insurance companies involved to question whether the case was actually work-related; because of this, the case remains open. However, because it was considered a work-related injury at the time the case was brought to OSHA, they visited with the company and completed a thorough inspection.

As part of the inspection, the compliance officer will ask to review injury/illness records (OSHA 300 logs) and often a copy of your company's safety manual which should include written programs for specific OSHA standards such as Lockout/Tagout, Hazards Communication and Personal Protective Equipment. Any concerns regarding your written documentation will be noted at this time.

The Walkthrough

Next the compliance officer will proceed to the inspection area(s). This gives the officer an opportunity to review various work and safety practices, consult with employees, take pictures and/or video, record instrument readings, collect air samples, measure noise levels and generally survey the areas in question. The officer will point out and record safety and

health concerns during the walkthrough. **Your employee representative should take notes and photos/video along with the officer for your company's records.** In addition, any concerns that can be corrected immediately *should be* corrected immediately. This will show the officer that you're willing and eager to comply.

Once the walkthrough is finished, the officer will execute a "closing conference." This conference includes the officer, the employer, the employee representative and any other employees deemed necessary. Each participant will receive a copy of *Employer Rights and Responsibilities Following an OSHA Inspection* (OSHA 3000) and the officer will review with the group each of the safety and health concerns he/she observed during the walkthrough. Each of these concerns *may* qualify for a citation and resulting penalty; expect that information to arrive after an OSHA Area Director has reviewed the compliance officer's reports and determined appropriate action.

If you received any citations and/or penalties, you'll need to "post a copy of each citation at or near the place" the violation occurred and leave it posted for three days or until the violation is corrected, whichever is longer. You may also be assigned a penalty for one or more citations (see sidebar on page 34), any or all of which can be appealed.

Wrapping Up Your Strategy

Having an OSHA compliance officer pop in probably isn't your idea of fun, but by being prepared you can take a lot of the stress out of the process. Use this simple checklist to keep you and your employees at-the-ready all the time.

- Establish a comprehensive safety program. Provide your program (or a summary version) to all employees requiring written acknowledgement they received their copy.
- Provide (and document) appropriate safety and health training sessions for all of your employees.

A Strategic Plan

Whether you're starting from scratch or you're just not sure your safety program is as thorough as it should be, WTCA's Operation Safety and Forklift Certification Program bundle can help! These industry-specific programs can help you create or improve your existing in-house safety programs by providing guidelines your management team can follow while building or augmenting your current programs. In addition, these programs both include multimedia employee training, various facility checklists and a collection of additional materials. From posters and employee handbooks to quizzes and forms, both programs were designed to help you build a thorough, organized safety culture in your facility. One additional course of action you might consider is choosing to participate in a voluntary OSHA compliance program. The best part? You won't be subject to a surprise OSHA visit. Read the stories of two component manufacturers that signed up for these programs in "Inviting OSHA In: Consulting with the Experts" (March 2008 SBC) and "OSHA: A Welcome Visitor" (March 2007 SBC).

- Stay informed about the OSHA standards that apply to your component manufacturing operations.
- Keep thorough, organized records in a safe, known location.
- Develop a plan and train your staff to ensure every employee knows how to react if a compliance officer arrives.
- Establish your employee representative today!

Finally, one of the most critical things you can do is institute an internal safety reporting system. Creating a safety culture in which your employees feel not only comfortable talking about safety concerns, but also confident that their concerns will be taken seriously and ultimately corrected, significantly lessens the chance that they will feel the need to turn to someone outside of your facility, namely OSHA, to complain. As always, your emphasis on safety and health issues will be reflected in your company and your employees, no matter who's standing at your door. Safety first! **SBC**



TRIAD
FLOOR BUILDER SYSTEM

Floor Framing Jig
Floor Builder Bridge
Floor Material Bridge
Accommodates Dimensional Lumber, Floor Trusses & I-Joists

Single Source for
Wall Panel, Sub Component,
Material Handling & Stair Building
Equipment!

800-568-7423 Ext. 133
308-384-1780 Ext. 133
<http://www.triadruvo.com>

For reader service, go to www.sbcmag.info/triad.htm



Tired of Waiting for the Market to Turn?

Slow times provide the perfect opportunity to be aggressive, reposition your business, look for new products and sell them to new customers.

Consider Trim-able floor trusses. With the use of Trim Fit I-Blocks you can easily begin production of Trim-able floor trusses. Sell them direct, sell them to wholesale distributors, sell them to retail lumber yards. No new equipment, no new software, no additional sales people and you keep your production line working.

Take control. Make the right turn to profit!

I-BLOCK

TRIM FIT
Trim it to fit!

www.trimfitllc.com
573-291-0101

For reader service, go to www.sbcmag.info/trimfit.htm

Eco-Label Offers Viable Chain of Custody Alternative

by Libby Maurer

Encourages sustainability—maximizes material efficiency—lowers energy costs—reduces impact on the environment. These are the primary objectives of building green. But some component manufacturers are beginning to wonder what transporting certified lumber over 1,000 miles has to do with any of these principles.

One thousand miles you say? That's the distance FSC-certified lumber would have to travel to reach a component manufacturer's operation located near the east coast. We had an interesting conversation with this component manufacturer (CM) who asked not to be identified. We'll call him John.

This particular CM recently reviewed a project specification that called for trusses built with FSC-certified wood. Since it was the first time John had seen certified wood in a spec, he did some research. Here's what he found.

"A couple months ago I didn't really know what 'green' was in the context of our industry. After reviewing the mission statement of FSC, I think it's a noble intention that needs major reform to be economically viable in the lumber and component industry," he said.

First John located the closest source for FSC-certified southern yellow pine: a mill in Arkansas. Lumber being shipped from Arkansas to his shop on the east coast would have to travel 1,200 miles. "Getting material shipped from across the country doesn't sound very green to me," John commented.

Next he costed out the job in two ways. In the first bid, he plugged in numbers for the FSC wood as specified. He used non-certified SYP in the second bid. (See Figure 1 for an example.) "For us to have done the job as specified, it would have been double the cost of a normal job using non-certified southern yellow pine," John said. "There's not much of a chance that anyone's going to pay another 50 percent of the cost for something that's designated 'green.' Not in this market."

His company never did the job. "Turns out we couldn't do it anyway because we're not FSC-certified," he said. This type of certification, known as chain of custody, is essentially a strict, if tedious, set of documentation procedures that track material from the forest to the jobsite. It typically applies to companies that manufacture, process or trade timber, and it is administered by forest management organizations like the Forest Stewardship Council (FSC) and the Sustainable Forestry Initiative (SFI). In order to establish chain of custody, one of the things CMs are required to do is separate certified lumber in their yards and inventories. "Just as lumberyards would be required to do, we would have to double our storage size and double our SKUs to have green lumber. And we can't afford it in this market!" he exclaimed.

John revealed another detail about chain of custody. Lumber can be considered "green certified" from the time a seedling is planted until it is milled, but the moment a non-certified component manufacturer (or any other secondary manufacturer) takes possession of the product, the chain of custody is considered broken. This is the case even though the lumber properties haven't been altered.

The more he read about the cost of providing certified green components, the more hypocrisies became apparent to John. Expending fuel to send lumber on a 1200-mile journey, implementing costly and cumbersome chain of custody procedures, and purchase costs that are far higher than what the current market will support.

All this red tape for an industry that is, at its very core, green. "I'm all for [sustainable building practices], but our industry is just about the greenest of all industries. Our goal is to be able to hold the amount of scrap generated from building a truss in the palm of your hand."

Continued on page 38

at a glance

- ❑ One component manufacturer found out that supplying green-built trusses can be very costly.
- ❑ Eco-certifiers like FSC and SFI impose strict chain of custody requirements on secondary lumber product manufacturers like CMs.
- ❑ A stamp placed on lumber that meets sustainable forestry criteria may be an ideal way for our industry to supply green-built products affordably.

POWER PRESERVED GLULAM™ BEAMS AND COLUMNS™

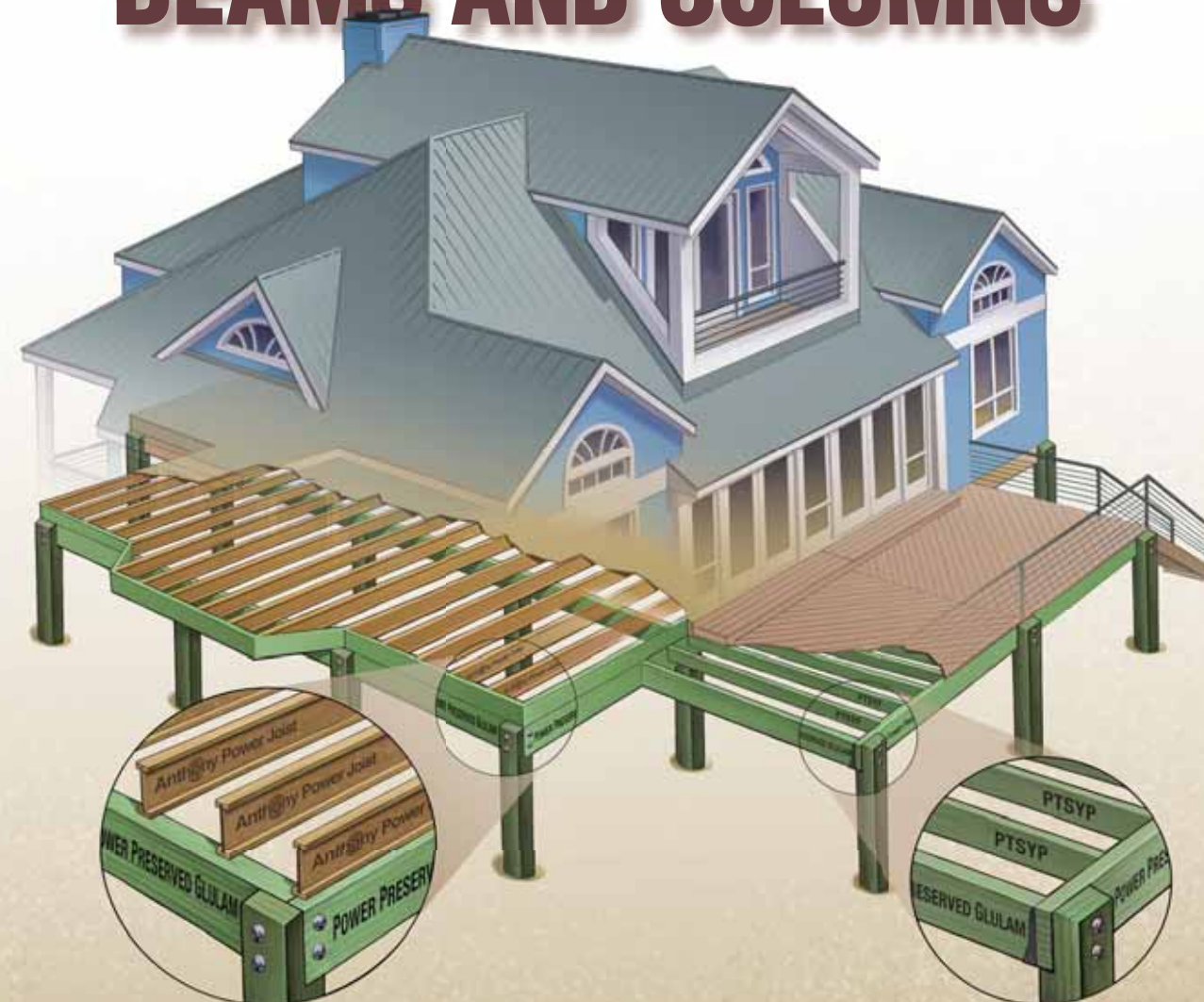

- Available in 3 1/2" and 5 1/4" widths at IJC and dimension lumber depths
- 24F Industrial Grade - zero camber - balanced beam and **Power Preserved Column™** combination #50
- Meets FEMA's guidelines for "Flood Resistant Materials"

- Treated by **HOOVER** with **Cop-Guard™** (CuNap) in low odor mineral spirits for above ground and ground contact

- Environmentally safe and easy to work with

- Perfect for deck beams and columns, raised floor construction, coastal construction using piling/column or pier and beam foundations

- Backed by a 25 Year Warranty as strong as our products

- Resistant to fungal decay and wood-destroying insect attacks



Tomorrow's Engineered Wood - Today™



Power Beam®



Power Joist®

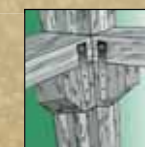

Power Column®



Power Log®



SYP Lumber

P.O. Box 1877 ▲ El Dorado, AR 71731 ▲ 800-221-2326 ▲ www.anthonyforest.com

Do you really
need a computer in
every tool?



theHAINCOMPANY
SOLID • SIMPLE • SOLUTIONS

Framing Tables From \$20,000
Measuring Systems From \$2,200
Sub Component Nailers
Rafters Cutters
Vent Block Drills

Call us for more information and mention
this ad to get a promotional discount.

www.haincompany.com
530.295.8068

For reader service, go to www.sbcmag.info/hain.htm



Roll Off Wall Panels &
Trusses Damage Free!



New & Used Trailers in Stock!

ANU PROSPECT

100 South Service Road • P.O. Box 89
St. Marys, Ontario N4X 1A9

(519) 349-2202 or
1-800-615-5122

For reader service, go to www.sbcmag.info/anuprospect.htm

Exposing the Truth about Chain of Custody • Continued from page 36

The Eco-Label Option

What can be done to address the severity of chain of custody but continue to serve the market and the end user with an affordable green-built product? Some manufacturers believe that the inefficiencies of certifying green building materials must be substituted with a common sense approach to providing affordable green options. Unless this is accomplished, green building may not be broadly accepted within the building components industry.

One idea is to develop an "eco-label," or an additional "green" designation that would identify lumber from sustainable forests. LBM Institute, an arm of NLBMDA, along with folks from all sides of the lumber industry, recently proposed the eco-label idea to FSC and SFI representatives at a forum in Kansas City (see sidebar on page 61 for more information about eco-labeling). "Someone with some business acumen has to get involved in determining how lumber is classified as green. This is why I found the eco-label concept so appealing," said John.

If implemented, this eco-label or lumber grade stamp enhancement would be similar to the grade stamps that now exist for lumber, with oversight provided by the American Lumber Standards Committee (ALSC) through a Department of Commerce standard, in a standard similar to the PS-20 lumber standard. The presence of an eco-label would make green-certified lumber instantly identifiable. It would permanently imprint the chain of custody at the point that the lumber leaves the mill, and could eliminate the need for downstream paperwork retention. It would also successfully integrate the needs of all eco-certifiers (FSC, SFI, PEFC, STFS, CSA among them) to promote sustainable forest management with the needs of the marketplace (affordable green-built buildings) for an easily understood approach that already exists—the lumber grade stamp.

Such a label or stamp would streamline the chain of custody requirements currently enforced by eco-certifiers on component manufacturers and lumberyards. This, of course, would make green-built components more affordable. "[Chain of custody] is just driving up costs needlessly in a time when we need to make houses more affordable," said John. Eco-labeling would have made it possible for his company to take the job, get lumber locally and sell component packages affordably. "It would really open up the supply side of the equation, which would lower costs and make green much more economically viable," John commented.

In the Meantime...

While eco-labeling is evaluated by the lumber industry and the eco-certifying community, there are a couple things component manufacturers can do when faced with the decision to pursue chain of custody certification. First, understand that green building is largely misunderstood. The notion of being green and building green is still pretty subjective, even though certifiers like FSC and SFI would have you believe otherwise. Your customers probably don't have a grasp of it, and neither do some of the people specifying green-built products. The education process of green building is young, and rife with confusion and misinterpretation.

Next, know your facts. The next time you see a spec calling out certified wood, do a cost analysis and share it with your customer. You could even include it with your bid (see Figure 1 for sample bid). Unless you're working on a commercial job for the government, chances are good he'll choose the cheapest option, which will almost always be the non-certified route.

Third, if green building certification is the builder's ultimate goal, research the requirements of the certification whether it's LEED, NAHB, Green Globes or any other program. You may be able to suggest other areas in which components can fulfill credits toward certification, even if they're not built with certified lumber. The resources at

Continued on page 40



SAFE • FAST • FLEXIBLE

VERSATILITY

- Straight Cuts
- Single and multiple mitre cuts
- Single and multiple bevel cuts
- Infinitely long scarfs and ripping
- Infinitely short 4-cut webs
- Birdsmouth and taper cuts
- Valley chords
- Trench and slot
- Floor truss members

FLEXIBILITY

- Left-right or right-left material flow
- Single, double or side by side stacking
- Volume production or small custom runs
- Interface to all major design software
- Upgrade path from modular design
- Zero set-up time

SAFETY

- Fully enclosed cutting chamber
- Chamber door interlocked to blade rotation



**IMPROVED,
FASTER
VERSION 5
SAW NOW
AVAILABLE!**

For USA & Canadian Sales
& Service contact:

Outback Machinery Services
Tel: (423) 923 2881
www.outbackms.com



CALL 1-888-88-RAZER
www.razerusa.com info@razerusa.com

For reader service, go to www.sbcmag.info/pfitech.htm

Figure 1. Sample Bid or Invoice.

The purpose of this chart is to demonstrate the costing of various value-added options that can be added to a bid. It is not meant to reflect prices with complete accuracy.

*Prices were omitted due to the numerous variables that exist in estimating truss cost (size, grade, takeoff method, etc).

**Prices given are based on rough estimates of certified Southern Yellow Pine derived from sources in Arkansas and Wisconsin, delivered to CMs on the east coast and the Midwest respectively.

PERFECTO TRUSS		Customer: Big Green Builder, Inc.			
		Contact: Dave			
		Job No.: 1280			
		Date: 8/11/2008			
QUANTITY	DESCRIPTION	PITCH	OVH	UNIT PRICE*	TOTAL Regular Truss Package*
39	30' Common Truss	6	12/12	xx	\$XXXX.XX
2	30' Hip sets	6/8/6	12/12/12	XXXX	\$XXXX.XX
2	20' Scissor Gable	8/4	12/12	XX	\$XXXX.XX
8	20' Scissor Truss	8/4	12/12	XX	\$XXX.XX
2	20' Girder truss	8	0/0	XXX	\$XXX.XX
2	20' Valley Sets	8	0/0	XXX	\$XXX.XX
1	Jobsite Package				
TOTAL:					\$6,400.00
FSC-Certified Package (east coast CM)**:					\$9,050.00
FSC-Certified Package (Midwest CM)**:					\$7,700.00
(Add other value-added options, e.g., mold-free package):					

Exposing the Truth about Chain of Custody

Continued from page 38

www.sbcindustry.com/greenbuild will help you interpret the language in each of these programs.

Finally, learn how to make the case about why components were, are and always will be green. Arguably the most important thing we can do as an industry is to spread the word that structural building components are the embodiment of green—raw material efficient and optimum value engineered for maximum waste reduction, all wrapped up in a very valuable and affordable product line. Remember, "Structural Building Components: Green Since 1952." The more we spread this message throughout the green building community, the quicker we will overcome the economic roadblocks of green building acceptance within the lumber industry.

Our industry must keep a running dialog about the following:

1. The true value of green building if it does not present the most affordable building option.
2. We need to find a way to work together to make the process as cost-efficient as possible, with the overarching goal of meeting the two very beneficial public policy goals of sustainability and affordability.
3. Whether the "chain of custody" concept be made effective and cost-efficient.

The bottom line? "Green building and chain of custody in its present state needs reform. It adds cost without adding value at a time when we all need more value for each dollar we spend," John said. "'Green' is a great concept and I hope that it is here to stay. Like all new ideas, we just need to refine it into its most productive form and help make it more accepted and viable for all." SBC



Serving the Truss Industry Since 1987

New & Used Models in Stock

573/736-2966
573/736-5515 fax
www.rollerbed.com
lee@rollerbed.com

For over 20 years, Lakeside Trailer has led the way in the component trailer industry with innovative ideas to assure your delivery operations remain efficient in today's competitive market. With more than 1700 truss trailers to our credit, Lakeside has perfected ways to reduce or eliminate your transportation concerns.

LAKESIDE TRAILER MANUFACTURING, INC.

For reader service, go to www.sbcmag.info/lakeside.htm



BCMC 2008 • DENVER, COLORADO • OCTOBER 1-3

MILE HIGH PERFORMANCE

Welcome to BCMC 2008!

BCMC Is Your Place for Planning, Evaluating & Adjusting

- Undertake your company's strategic planning HERE!
- Break into new markets/products
- Research future business costs
- Build leaders in your company
- Gain perspective on how to endure the market downturns
- Assess how to gear up when the next market upswing occurs
- Research current and future purchasing decisions in one location
- Improve efficiency and communication in your plant
- Learn about green building and how to implement it
- Learn effective processes for your design department
- Gain knowledge on building codes and key technical information
- Find out the latest in industry research and testing
- View active machinery demonstrations
- Discover the latest and greatest products and services
- Reconnect with your peers and discuss current issues
- Discuss the state of the industry with industry professionals

www.bcmcshow.com
info@bcmcshow.com
608/268-1161 phone
608/274-3329 fax

MESSAGE FROM THE BCMC CHAIR

It is my honor to welcome you to Denver, CO for the 28th annual Building Component Manufacturers Conference. Again, I would like to thank you for coming to Denver and supporting BCMC. Investing in our future is the reason we are all here.

Exhibitors and attendees alike will benefit from attending the show and immersing their teams in a week of connecting with others and building passion for advancing the industry. And if ever there was a time to strategize, this fall will be that time.

Although there have been a couple turbulent years, we are still focused on the same goals, BCMC will showcase the latest technologies, helping you learn to improve efficiency and communication, break into new markets/products as well as how to gear up when the next market upswing occurs. BCMC is your place for planning, evaluating and adjusting your business to make it a success.

BCMC offers you the opportunity to research future business costs, gain perspective on how to endure the market turns, discuss the state of the industry with other industry professionals by attending roundtable discussions, listening to Dr. Stanley Duobinis's economic forecast, walking the show floor, and of course networking with your peers.

Regardless of the state of the economy, you and your coworkers will leave BCMC with insight on how to deal with these issues using the valuable information you have been provided with. I look forward to seeing you in Denver.

Thank you and welcome to BCMC 2008!

Steve Shrader
2008 BCMC Committee Chair



VIEW THE FLOOR PLAN AT WWW.BCMCSHOW.COM

Golf Sponsor BCMC Bowl Sponsor

- A-NU-PROSPECT
- Aegis Metal Framing, LLC
- Alpine - ITW Building Components Group
- Alpine Equipment – ITW Building Components Group
- Alpine Systems Corporation
- Ameri-CAD – VisionREZ – ITW Building Components Group
- Anthony Forest Products
- Arch Wood Protection
- Bloch Lumber Company
- Boscus Canada Inc.
- BOSS Tiedowns & Strapping
- Bowermaster & Associates
- CADWORK
- Canadian Engineered Wood Products Ltd
- Canfor Wood Products Marketing Ltd.
- Carbeck Structural Components Institute
- Carolina Strapping and Buckles Company
- Clark Industries, Inc.
- CMF Inc., Commercial Machinery Fabricators
- CMS North America, Inc.
- Cold-Formed Steel Council
- Combilift USA
- Component Runner, LLC
- Cordstrap USA
- Custom-Arch
- Dansco Engineering, LLC
- Deacom, Inc.
- DEMILEC (USA) LLC
- Dietrich's North America 3D CAD/CAM Software
- Dow Building Solutions
- Eagle Metal Products
- Eide
- Enventek
- FastenMaster
- Finnforest USA, Engineered Wood Division
- Gilman Building Products
- Greenleaf Trading
- GULF LUMBER COMPANY, INC.
- Hardy Frames
- Heaven & Earth Therapeutic Massage, Inc.
- Hiab, Inc. A Cargotec Company
- HLPC & Supply, Inc.
- hsbCAD – ITW Building Components Group
- HOLTEC (USA) CORPORATION
- Hundegger USA, L.C.
Sponsor: Pens at registration
- iLevel by Weyerhaeuser
- Intelligent Building Systems - ITW Building Components Group
- International Beams, Inc.
- ITW Building Components Group
- ITW - Industrial Fastening – Manufacturer of Paslode and Duo Fast
- ITW Panel Fastening Systems
- J. M. Boyle & Associates, LLC
- Keymark Enterprises
- Klaisler Mfg Corp.
- Koorsen Manufacturing Inc.
- Lakeside Trailer Mfg., Inc.
- Lignum Forest Products
- LP Building Products
- Lumbermens Merchandising Corporation - LMC
- Metriguard
- MiTek Industries, Inc.
Sponsor: Educational Track Handouts, Ad on inside back cover of Educational Track Handouts
- Monet DeSaw Inc.
- MSR Lumber Producers Council
- Nordic Engineered Wood
- NUCONSTEEL
- OptiFrame Software, LLC
- Pacific Automation Ltd - MiTek
Sponsor: Hotel Room Promotion Piece on Thursday
- Pacific Trail Mfg., Inc.
- Palfinger North America
- Panels Plus
- Pelican Bay Forest Products
- Pennsylvania Lumbermens Mutual Insurance Co.
- PFP Technologies
- Popular Equipment Finance
- Precision Equipment Mfg.
- Princeton Delivery Systems Inc.
- Qualtim, Inc.
- Randek BauTech AB
- Rayonier Wood Products
- Rex Lumber LLC & North Florida Lumber
- Robbins Engineering, Inc.
- Robbins Lumber
- SBC Research Institute
- Senco Products, Inc.
- Simpson Strong-Tie
- SL-Laser Systems
- Southern Pine Council
- SpaceJoist TE, LLC - ITW Building Components Group
- SPIDA MACHINERY
- Spotnails
- Stanley-Bostitch
- Stiles Machinery Inc.
- Structural Building Components Magazine
- Summit Forest Products Inc.
- SUNBELT
- The Hain Company
- The Koskovich Company
- Timber Products Inspection
- Todd Drummond Consulting, LLC.
- Triad/Merrick Machine Company
- Trim Fit, LLC
- Truss Plate Institute
Sponsor: Directional & Meeting Room Signs, Lanyards, Tote Bags, "You Are Here" Location Signs
- TrusSteel - ITW Building Components Group
- Truswal - ITW Building Components Group
- Turb - O - Web
- USP Structural Connectors
- Viking WPS
- Virtek Vision International, Inc.
- Vision Financial Group, Inc.
- Wasserman & Associates
Sponsor: Tote Bag Insert
- West Fraser
- Wood Truss Systems, Inc.
- WTCA - Representing the SBC Industry

- Stanley-Bostitch
- Stiles Machinery Inc.
- Structural Building Components Magazine
- Summit Forest Products Inc.
- SUNBELT
- The Hain Company
- The Koskovich Company
- Timber Products Inspection
- Todd Drummond Consulting, LLC.
- Triad/Merrick Machine Company
- Trim Fit, LLC
- Truss Plate Institute
Sponsor: Directional & Meeting Room Signs, Lanyards, Tote Bags, "You Are Here" Location Signs
- TrusSteel - ITW Building Components Group
- Truswal - ITW Building Components Group
- Turb - O - Web
- USP Structural Connectors
- Viking WPS
- Virtek Vision International, Inc.
- Vision Financial Group, Inc.
- Wasserman & Associates
Sponsor: Tote Bag Insert
- West Fraser
- Wood Truss Systems, Inc.
- WTCA - Representing the SBC Industry

Listing as of 8/13/08



GO ONLINE FOR MORE INFORMATION & TO REGISTER

Everything you need to know about this year's show is only a mouseclick away. Check out our website to learn more about sessions, roundtables, speakers, exhibitors, hotels, golf and more!

Visit www.bcmcshow.com and register to attend.

KEY: Gold SBC Advertiser • Silver SBC Advertiser • Bronze SBC Advertiser • Asterisk (*) indicates a new exhibitor

A-NU-PROSPECT

See ad on page 38

A-NU-PROSPECT provides the wood component industry with effective delivery systems. These trailers are of the highest quality in the industry featuring innovative improvements on an old concept. These trailers reduce delivery and maintenance costs while being more driver friendly than other trailers.

Contact: Mr. Joe Wilhelm • 519/349-2202 • 519/349-2342
joewilhelm@quadro.net • www.trusstrailer.com

Aegis Metal Framing, LLC

Alpine - ITW Building Components Group

See ad on pages 32-33

Alpine's powerful ProVIEW software is a complete package offering "whole house" design, from the first floor to walls all the way to the roof. By integrating wall panels, trusses engineered wood products and conventional framing into one product, ProVIEW reduces errors and improves performance. Our full service passionate approach to business means Alpine customers enjoy industry leading products paired with exceptional support. Engineering principles drive everything we do so all system works together to give our customers unwavering confidence in the building components they produce.

Contact: Mr. Ken Kuehn • 817/633-5100 • 817/652-3079
kkuehn@itwbccg.com • www.alpeng.com

Alpine Equipment – ITW Building Components Group

Alpine Equipment's dedication to reliability and innovation enables truss manufacturers to meet the challenges of today's tight budgets and complex designs. Let us show you how we can help improve your bottom line. The automated in feed and out feed system of the innovative ALS make cutting a one man operation. The RAM-EZ Rider with automated C4 jiggling sets up any truss in 30 seconds or less! Alpines e-SHOP helps you control costs and improve production! Alpine Equipment's staff is the most skilled in the industry we assist with financing, plant layout, installation, parts, service and maintenance plans,—whatever it takes!

Alpine Systems Corporation

Alpine Systems is a full service supplier of metal connector plates to wood truss manufacturers across Canada. Alpine's full line of products and services includes complete engineering service; proprietary software, support and training; and a complete line of cutting, assembly and material handling equipment for truss and wall panel manufacturers.

Ameri-CAD – VisionREZ – ITW Building Components Group

VisionREZ by Ameri-CAD is an architectural productivity program for residential applications. Powered by Autodesk Technology, VisionREZ enables the user to communicate ideas clearly, generate re-usable data for estimating, and collaborate with manufacturing, suppliers, and subcontractors. Efficiently create coordinated 3D Models, Construction Documents, Framing, Graphics, Bill of Materials and more.

Anthony Forest Products

See ad on page 37

Anthony Forest Products Company is an integrated forest products business begun in 1916. The company owns approximately 91,132 acres of timberland in Arkansas, Louisiana and Texas. It operates southern pine lumber producing mills in Urbana, Arkansas and Atlanta, Texas; and wood chip mills in Plain Dealing, Louisiana and Troup, Texas. The company also operates engineered wood laminating plants in El Dorado, Arkansas and Washington, Georgia. Anthony Forest Products Company and Domtar, Inc. of Montreal, Canada jointly own and operate an I-joist manufacturing plant in Sault Ste. Marie, Ontario.

Contact: Mr. Chris Webb • 870/862-3414 • 870/862-6206
cwebb@anthonyforest.com • www.anthonyforest.com

Arch Wood Protection

Protect your customers and your reputation against mold by using and producing -- FrameGuard® mold-resistant wood. Arch Wood Protection has introduced a mold-inhibiting coating that protects wood products against mold, termites, and fungal decay. Suitable for factory-application on lumber, OSB, engineered wood products, trusses, and SIPs, the end products are being promoted as FrameGuard® mold-resistant wood, winner of a 2007 NAHB Green Building Award and listed in the GreenSpec® directory. Arch Wood Protection is also developer of Wolmanized® pressure-treated wood and Dricon® fire retardant treated wood.

Bloch Lumber Company

Bloch Lumber—Specializes in Guaranteed Forward Pricing, a risk management tool for the lumber and building materials industry. Bloch's industry role also includes the distribution of commodity lumber and panel products.

Boscus Canada Inc.

Boscus Group consist of lumber industry related companies: producers (Berscifer Forest Products), remanufacturing (Rembos), wholesale, distribution and transportation. Member of the MSR Lumber Producers Council, we have been supplying truss and others building components manufacturers for over 15 years. We distribute Canadian SPF, all grades and dimensions, all over North America and overseas. MSR and #1&2 represents 60% of our volume. We rapidly adapt to changing markets to offer a variety of solutions for all our partner's unique needs. Visit our boot for more information on our products and services.

BOSS Tiedowns & Strapping

BOSS Strapping is a lightweight, flexible, heavy duty woven polyester that is rapidly replacing rigid and dangerous steel banding. Our polyester is made in the USA and manufactured into durable strapping in Texas. Because BOSS strapping is made of strong, durable polyester, it holds loads despite nicks, frays and even small cuts. And weighing one-fourth of steel banding, BOSS Strapping is easier on the back and strap choppers are not needed. Quality and consistency of strapping are the primary concerns of BOSS. This is achieved with in-house quality monitoring throughout the entire manufacturing process. Manufactured in Texas, USA.

Bowermaster & Associates

Bowermaster & Associates is an expert partner with the WTCA. We are the leader in providing the Building Component Industry with the best coverage at the lowest cost. Over 40 truss manufacturers choose Bowermaster's Woodpro specialists to protect their insurance needs. Bowermaster & Associates is a full service insurance agency offering Property and Casualty insurance, Workers' Compensation, Health and Employee Benefits, Retirement and Financial Planning, and Human Resource Consultation. Stop by and see what we can do for you.

CADWORK

CADWORK is a unique 3D package that enables you to produce full documentation of your projects and create data for fully-automated CNC equipments and non-automated manufacturing. Thanks to its flexibility, you can efficiently build wall, floor and roof panels according to your building system and work out a solution for all details. From the Architecture to the last component, CADWORK will help you!!

Canadian Engineered Wood Products Ltd

CEWP is a national distributor of truss-related material, such as MSR lumber, Quality 1&2 and web stock. Our team of twelve traders in Alberta, British Columbia, Quebec and Ontario allows us to provide the best options for our customers in both the eastern and western markets. In January of 2002, we were pleased to announce our agreement with Millar Western Forest Products, becoming Millar's sole distributor of MSR lumber.

KEY: Gold SBC Advertiser • Silver SBC Advertiser • Bronze SBC Advertiser • Asterisk (*) indicates a new exhibitor

Canfor Wood Products Marketing Ltd.

Canfor is North America's largest SPF MSR producer, servicing the truss manufacturing, I-joint manufacturing and building components industries. Canfor is your most reliable supplier of MSR, producing consistent quality kiln-dried SPF MSR at 7 mills in prime grades of 1650, 1950, 2100, 2400 in lengths up to 20ft. Canfor also manufactures long length finger-joined MSR up to 36ft. Canfor offers reliable supply options; rail directly from our mills or trucks from one of our 8 North American reloads.

Carbeck Structural Components Institute

Carbeck Structural Components Institute (CSCI), a 501(c)3 non-profit organization, undertakes research and education projects focused on the structural framing of residential housing and commercial buildings. One of CSCI's key objectives is to provide the fire service with education and information concerning how to effectively and safely put out fires in structures that include structural building components. Your support last year allowed CSCI to produce a new online educational program entitled "Ad Hoc Demonstration Fire-Sheathed Unprotected Floor System" based off of a live burn demonstration that happened in Colonie, NY, as well as new updates to the www.carbeck.org website.

Carolina Strapping and Buckles Company

Carolina Strapping and Buckles Company is the proud manufacturer of GatorSTRAP™, the widely accepted heavy duty woven polyester strapping that is used extensively in the North American lumber and building component industries. MakoSTRAP™, a composite polyester strapping, was recently introduced. Both GatorSTRAP™ and MakoSTRAP™ are safe and economical alternatives to steel strapping. CS&B also manufactures phosphate coated, extra grip wire buckles for GatorSTRAP™ and galvanized wire buckles for MakoSTRAP™. Carolina Strapping and Buckles Company is your source for strapping and buckles for any application.

Clark Industries, Inc.

See ad on pages 13, 60

Clark Industries, Inc. builds equipment to maximize your productivity while minimizing your labor dollars. Our roof truss systems require 2-3 man crews and allow raw materials to remain on the table during assembly and the pressing cycle. Our multi-head system simultaneously presses all nail plates. Single-Pass Floor Truss Production Systems. 100% nail plate embedment is our standard, eliminating the need for finishing equipment. CII provides an assortment of roof and floor truss presses, stand-alone jack presses, column laminators, horizontal and peak-up stacking systems. Come by our booth to discuss your standard or custom equipment needs.

Contact: Mr. Jack Schulz • 417/235-7182 • 417/235-8262
jack@clark-ind.com • www.clark-ind.com

CMF Inc., Commercial Machinery Fabricators

See ad on pages 22-23

Commercial Machinery Fabricators, Inc. offers a number of products, and will exhibit some of these at BCMC '08. Products include: New Trackless Gantry with a 24-inch Roller VF Drive with power pack, a Roller Press with 24-inch rollers, Steel Slotted truss tables with 24-inch steel plate and plastic/wood top tables, Trackless Floor Truss and Trackless Jack Table.

Contact: Mr. Edward G. Joseph • 517/323-1996 • 517/323-8939
ed@cmfstealth.com • www.cmfstealth.com

CMS North America, Inc.*

CMS North America, division of CMS Industries of Zogno(BG) Italy, manufacturer of CNC Machining Centers, high-speed routers (3-,4-,5-axis) since 1969. Specializing in Timber Frame/Log Construction CNC Machining Centers and Software to produce all required parts with joinery. Machines for working wood, composites/plastics, aluminum, stone, glass, solid surface material. Pinnacle of technology and innovation backed by user-friendly software, training, 24/7 tech support/service (large staff factory trained), extensive Parts inventory all based in

USA. Design, durability, dependability! CMS mission, to provide CNC solutions to meet customer manufacturing needs.

Cold-Formed Steel Council

See ad on page 15

WTCA formed the CFSC to focus on issues that affect manufacturers of steel structural building components. The goal of CFSC is to protect and educate component manufacturers through risk management and training material. This year, CFSC has created a Cold-Formed Steel Building Component Safety Information booklet. Stop by our booth to see all of CFSC's new products and services.

Contact: Ms. Jill Zimmerman • 608/274-4849 • 608/274-3329
jzimmerman@sbccindustry.com • www.cfsc.sbccindustry.com

Combilift USA

The Combilift multi-directional forklift is designed for handling long and awkward loads in confined spaces within a wide variety of sectors including the aluminum industry. Its robust design and super elastic tyres enable it to work inside and out, on semi-rough terrain and in all weather conditions. Double handling of goods and downtime due to battery charging are a thing of the past with Combilift, as trucks are powered by LPG or diesel. Capacities range from 2.5 to 10 tonnes with a variety of attachments to cater for individual customers requirements. Call for Free Video & Warehouse Design.

Component Runner, LLC*

Component Runner, LLC is a Structural Building Components design outsourcing firm offered exclusively for MiTek 20/20 customers. Component Runner uses a combination of USA Project Managers with 15+ years of industry experience and highly trained India based design technicians resulting in high quality at an affordable price. Component Runner services include: complete building modeling using MiTek eFrame Layout, Panel and MiTek TrussFramer software. We offer truss design services using MiTek 20/20 engineering matched with your defaults and preferences. We provide complete wall panel design services and loose framing material takeoffs as well. Come visit us inside the MiTek booth.

Cordstrap USA

Cordstrap® is the world leading manufacturer of corded polyester strapping and one-way load securing systems. We provide customers with a safe and cost-efficient alternative to steel banding and other conventional transport packaging materials. Since 1965 it has been Cordstrap's mission to solve strapping, transport, load securing complexities and safety challenges for a diverse base of customers. Cordstrap CC105 is now AAR certified, offering the highest standards available. Cordstrap® Composite Strapping (CC) is a latest development in non-metallic strapping technology. Made from high tenacity polyester filament yarns embedded in a polymer coating, composite strapping is often referred to as synthetic steel.

Custom-Arch

Arches by Custom-Arch are pre-fabricated to the exact specifications of our home-builder customers. Our wooden arches are pre-mitered to slip into your panels with ease and nail in place quickly with your standard nail guns. Perfect curvature, strong, durable, and economical...If you want to add value to your wall panels by installing arches, you owe it to yourself to consider Custom-Arch.

Dansco Engineering, LLC

Dansco can provide your company with seals, sealed repairs and layouts in 26 states currently, including the recently added state of ILLINOIS. Dansco is also a regional leader in several other building industry related fields: Multifamily Building Design and Structural Engineering, Whole House Residential Design and Engineering, Site inspection, Shoring Design and Inspection for Concrete Formwork & Drafting and Design Work. Dansco prides itself in providing faster turnaround times at a lower cost than many of our competitors and to achieving and maintaining 100% customer satisfaction time after time. Let us show you how Dansco can save you time and money and become part of your team.

KEY: Gold SBC Advertiser • Silver SBC Advertiser • Bronze SBC Advertiser • Asterisk (*) indicates a new exhibitor

Deacom, Inc.

Deacom, Inc. produces the DEACOM Integrated Accounting & Enterprise Resource Planning (ERP) Software System for building component and modular building manufacturers with hard-to-handle requirements. The DEACOM ERP System is engineered to manage your complex job costing and business process issues, and handles an endless variety of unique requirements without costly customization. DEACOM Software seamlessly integrates all areas of your company—from built-in engineering links and inventory control, to order entry and invoicing—giving you a comprehensive view of your entire operation. Visit the Deacom booth for a demonstration, and learn how DEACOM can maximize your productivity and profitability.

DEMILEC (USA) LLC*

DEMILEC (USA) provides spray foam insulation solutions for energy efficient designs. The superior performance of DEMILEC (USA)'s products is driven by the synergy of innovative minds, premium quality components, and pioneering chemistry of spray foam technology. DEMILEC (USA) is a pioneer in the development and commercialization of environmentally-safe spray foam insulation products for wood or steel structures and produce the totally water-blown SEALECTION® 500 insulation system. Debuting in 2008 are our Green systems that are based in renewable natural resources—SEALECTION Agribalance® and HEATLOK SOY®, a green product that uses the environmentally-friendly blowing agent Enovate™ 3000, manufactured by Honeywell.

Dietrich's North America 3D CAD/CAM Software

Dietrich's 3D CAD/CAM software offers a fully integrated modular system for the prefabrication and modular building component industry. The Dietrich's System is not only a CAD/CAM program. Together with specialized CAD functions for construction, it produces all files for the manufacturing process, detailed costing and quoting preparation, and marketing documents. Our system of program modules is flexible and meets most standard needs, however, tailor-made solutions are also possible. Meet with us to discuss your software solutions.

Dow Building Solutions*

From Dow Building Solutions comes an industry first – a single product that combines insulation, structural shear bracing and water-resistive barrier properties. STYROFOAM SIS™ Brand Structural Insulated Sheathing is a three-in-one solution that meets building code requirements for racking while also achieving significant R-values. For the builder—Saves time—requiring only one trip around the house...Saves Money—in addition to saving on labor costs by reducing installation time, utilizing the STYROFOAM SIS wall system cost is comparable to an OSB/housewrap combination in many instances. For the Home Owner—Energy Savings Year Round. Learn more at www.insulateyourhome.com

Eagle Metal Products

See ad on page 31

Eagle Metal Products is a family-owned company driven to provide our customers with high quality products and unequalled customer service. Eagle Metal provides component manufacturers with connector plates, design software, engineering services and truss equipment. Visit our booth to experience our TrueBuild® structural component software, meet our knowledgeable staff and check out our new products being introduced in 2008. See why Eagle Metal is becoming the supplier of choice for component plants today!

Contact: Mr. Baird Quisenberry • 800/521-3245 • 972/888-9966
baird@eaglemetal.com • www.eaglemetal.com

Eide

See ad on page 53

Eide debuts more revolutionary new products and demonstrates the industry's #1 automated jig system. WizardPDS® is the fastest growing system in the industry with over (60) sold since BCMC '05. The WizardPDS®—Perimeter Definition System is a fully automated jig system that reduces truss setup time by 99%. WizardPDS® requires NO additional jig hardware or images to accomplish a complete truss set up in 30 seconds or less. The WizardPDS® converts what is now setup time to build time. Visit our Booth and see the WizardPDS® build (7) individual and completely different trusses start to finish in 22 minutes.

Contact: Mr. Thomas P. Hoy • 612/521-9193 • 612/521-9307
tom@eidemachinery.com • www.eideintegratedsystems.com

Enventek*

Enventek manufactures user friendly, safe and inexpensive automation for your company. We retrofit certain types of component saws with servo technology allowing us to be very competitive in price. Our innovative saw feeding system improves saw safety and speed. It allows our component saws to not only compete with new technologies by cutting over 80 pieces a minute, but also surpasses them in cost and performance. Get a high performance automated component saw that is better than new for a fraction of the cost. Come see the future of the component saw at www.enventek.com.

FastenMaster

FastenMaster, a division of OMG founded in 1981, is a brand of task specific, contractor quality fasteners that are engineered to enable a professional to complete a project faster, easier and stronger. For additional information please call us at 800.518.3569 or visit our website www.FastenMaster.com.

Finnforest USA, Engineered Wood Division

See ad on page 11

Finnforest USA, Engineered Wood Division distributes Master Plank® LVL throughout North America. Master Plank® has all building code acceptances, including NER. Multiple span capabilities make this engineered wood product a logical choice for beams, headers, scaffold planks, mobile home, stair stringers and other industrial applications.

Contact: Mr. Robert Loew • 586/296-8770 • 586/296-8773
robert.loew@finnforest.com • www.finnforestus.com

Gilman Building Products

Gilman Building Products Company is a quality southern yellow pine manufacturer servicing the truss industry since 1972. Gilman's annual production of SYP lumber exceeds 600 million board feet per year with 75% of production going directly to the truss and component manufacturing industry. We invite our current customers and friends to stop by and visit, as well as prospective customers in the truss industry that are not currently doing business with us.

Greenleaf Trading*

Greenleaf trading specializes in MSR, visual grade lumber, web stock, panels, OSB for the component industry. We have 5 distribution centers in the U.S. supplying truckloads of component lumber products. Greenleaf also focuses on longer term forward pricing from 3 months to 24 months for your projects. A veteran industry trader can custom design inventory programs and direct buys to help you compete in the marketplace.

GULF LUMBER COMPANY, INC.*

GULF LUMBER COMPANY—Manufacturers of Southern Pine Lumber since 1940. Modern methods, high standards and industrial foresight have marked the history and growth of this company with a commitment to excellence through the production of quality products such as machine stress rated lumber, standard dimension grades, treated lumber and other specialty items.

KEY: Gold SBC Advertiser • Silver SBC Advertiser • Bronze SBC Advertiser • Asterisk (*) indicates a new exhibitor

Hardy Frames

Hardy Frames, Inc. manufactures and markets the revolutionary Hardy Frame® shear wall system. The Hardy Frame® is a state of the art pre-fabricated shear panel that is specifically tested to resist lateral and uplift forces resulting from high wind and earthquake loads. The Hardy Frame® is typically used in narrow wall areas around windows or garage openings to brace the wall. The Hardy Frame® exceeds the most stringent requirements of the 2006 IBC and IRC building codes. To learn more about how the Hardy Frame® can work for you and your customers please visit us at the MiTek booth.

Heaven & Earth Therapeutic Massage, Inc.*

Hiab, Inc. A Cargotec Company

Hiab, Inc. offers Hiab articulated cranes for off loading components and setting both bundles of trusses or single trusses. We also offer the Moffett truck mounted forklift for off loading and placing components on the jobsite including a 4-way version for handling extra long lengths of components. We are proud to offer Total Care—the complete service program, giving total confidence before, during, and after the sale. Please contact our Corporate Headquarters in Ohio at 1-800-852-2331 to locate a branch near you.

HLPC & Supply, Inc.

Let HLPC & Supply save you time, money and headaches! We manufacture truss vent blocks, specializing in high quality 2x4 to 2x14 vents. We can mill solid and beveled blocks to your specifications. We can also supply web stock to expedite the manufacture of floor webs. We manufacture our products as if they are going to be used on our own homes. Our purpose is to consistently supply quality wood products at competitive prices. We strive to build a long-term business relationship based on mutual trust and profitability. Quality and satisfaction are our top priority!

hsbCAD – ITW Building Components Group

hsbCAD produces Computer Aided Design (CAD) software to the construction industry, specializing in wood construction. Powered by Autodesk Technology, their software translates all data from architectural drawings into fabrication drawings and then creates the required CNC-files for automated equipment. The Design tool of Choice for: Timber Framers (Post and Beam), Modular Home Design, Residential Designers, Residential Design, Log home Design, SIP Designers, and Builders.

HOLTEC (USA) CORPORATION

See ad on page 4

HOLTEC—The worldwide leader in package crosscut systems. Our Transcut® II Portable Crosscut Saw is affordably priced at \$6900 for cutting whole bunks of lumber of length and our HOLTEC Precision Crosscut Systems are in use by over 7,000 customers worldwide to cut whole packages of lumber to length in less than one minute with a precision of +/- 1mm.

Contact: Ms. Kim O'Brien • 813/754-1665 • 813/752-8042
kim@holtecusa.com • www.holtecusa.com

Hundegger USA, L.C.

See ad on page 9

Hundegger USA: As a true Whole House Saw Hundegger is the most flexible machine on the market with the largest cross section cut area and the most advanced servo control. That is what separates a Hundegger machine from other component saws on the market. In just under 4 years Hundegger USA has sold over 350 SC-1 machines world wide and 1/3 of those in North America, making the SC-1 the most admired and complete linear saw on the market. Hundegger continues to define what a linear saw can do for the truss component industry and the EWP component industry as well.

Contact: Mr. Kip Apostol • 435/654-3028 • 435/654-3047
kip@hundeggerusa.com • www.hundeggerusa.com

iLevel by Weyerhaeuser

iLevel by Weyerhaeuser brings the most innovative and trusted products for building component manufacturers together under one roof. At the 2008 BCMC Show, we will feature Performance Tested® Lumber and iLevel Trus Joist® TimberStrand LSL, along with Javelin® design software and NextPhase® Site Solutions. Javelin is next-generation software, powered by OptiFrame®, for iLevel customers providing structural framing to builders. Javelin software is fully parametric and interoperable with TrussFramer™ files. NextPhase Site Solutions offer building material dealers and component fabricators a combination of proprietary software, industry-leading fabrication equipment, and consulting services, customized to meet the specific needs of their business.

Intelligent Building Systems - ITW Building Components Group

See ad on page 63

Intelligent Building Systems, the leading supplier for the wall panel manufacturing industry, provides additional profit opportunities for component manufacturers by providing a COMPLETE WALL PANEL SYSTEM. Our innovative equipment—manual, semi-automated, or fully automated systems—include exclusive features that give you an edge over your competition. We will provide the perfect combination of IntelliBuild™ software, equipment and service for any component manufacturer. Our knowledgeable staff will help you determine how to maximize your company's performance. Stop by and see how we can contribute to YOUR SUCCESS with our INNOVATIVE COMPLETE WALL PANEL SYSTEM.

Contact: Mr. Michael Schwitter • 817/633-5100 • 817/652-3079
mschwitter@itwbcbg.com • www.itwbcbg.com

International Beams, Inc.

At International Beams Inc. we take pride in providing our customers with premium quality products and services. Our I-joists are manufactured to provide consistent, high performance floor and roof systems. Our technical services consist of highly trained technical experts available to assist you with any design or construction question and to provide full support for our software. Our I-joist plants are located in New Brunswick & Quebec, Canada and have been producing high quality solid-sawn wood I-joists since 1995. We are constantly looking for new ways to improve our product and are committed to developing all the tools required to enable our distributors to service their customers, and ultimately the end user to the fullest.

Contact: Mr. Phillip W. Barkey • 574/269-2221
phil.barkey@lebcorp.com • www.internationalbeams.com

ITW Building Components Group

See ad on pages 32-33, 63

Discover new ways to increase your productivity and profits with ITW Building Components Group the leading supplier of technology-driven products and services for the building industry. Review powerful new software from Truswal and Alpine that will dramatically increase your office efficiency. Need to cut labor costs? See the enhanced ALS saw and AutoSet C4 jiggling system from Alpine Equipment. Financing available! Grow your business with wall panel equipment from IBS. Monitor every detail of plant production with e-SHOP. Add more profit to your bottom line with TrusSteel and SpaceJoist TE. Get the solutions you need from ASC and Alpine Systems in Canada.

Contact: Mr. Karl Bickel • 314/344-9121 • 314/344-3157
kbickel@itwbcbg.com • www.itwbcbg.com

ITW - Industrial Fastening Systems - Manufacturer of Paslode and Duo Fast

ITW Industrial Fastening are manufacturers of both the Paslode and Duo-Fast brand of tools and fasteners. Our Industrial focus allows us to concentrate on in-plant applications, especially truss, cabinet, and furniture. We specialize in analyzing plant challenges and providing solutions that increase productivity, quality, and efficiency.

KEY: Gold SBC Advertiser • Silver SBC Advertiser • Bronze SBC Advertiser • Asterisk (*) indicates a new exhibitor

ITW Panel Fastening Systems

ITW Panel Fastening Systems is a supplier of pneumatic and Cordless nailing, stapling tools and fasteners for the wood panel industry. We offer Paslode, Duo-Fast and ToolMatic brand tools and fasteners. Our tools are compatible with all U.S. and European automated panel equipment and tools are available with high capacity magazines. ITW Panel Fastening Systems offers an extensive service network to maximize production efficiency, as well as Engineering support when necessary.

J. M. Boyle & Associates, LLC

J.M. Boyle analyzes methods for reducing manufacturing costs, increasing revenue and reducing risk for start-up and existing wall panel and component manufacturing facilities. Operational deliverables include: feasibility studies, lender ready business plans, operational reviews and audits, training and quality control manuals, bidding and estimating models, and company processes, procedures and checklists. Sales and marketing deliverables include: training sales team's "methods of marketing and selling wall panels", sales presentations which create value, responses to customer objections, power point presentations of manufacturing services; and marketing activities designed to educate prospects on how component assemblies can decrease expenses, increase income and manage consequences.

Keymark Enterprises

Whole House Design, Single Building Model Technology, Intelligent Building Design, Building Information Modeling—KeyBuild is the embodiment of these catch phrases. Keymark is your one stop shop for integrated floor, wall & roof design software, along with truss plate supply, engineering services, machinery interfaces, & pre-cut/mark/route expertise. Visit Keymark's booth at this year's BCMC and witness how theory is becoming everyday practice at Keymark!

Klaisler Mfg Corp.

See ad on page 11

NOW IS THE TIME! Klaisler Mfg. Corp. wants to help you increase your production, decrease your overhead and make better components. We manufacture a complete line of equipment for the building components industry. EQUIPMENT IS WHAT WE DO! We build it all including our M Series line of comparably priced equipment, our Rolsplicer chord splicing machine, and our latest roof truss equipment designed for use with the PLANX or Wizard automatic jiggling systems. NOW IS THE TIME TO UPDATE! Let us show you how.

Contact: Mr. Brent Davis • 877/357-3898 • 317/736-0648
brent@klaisler.com • www.klaisler.com

Koorsen Manufacturing Inc.

Quality doesn't cost, it pays!...with the NEW Connector Detector. Only every few years does a new piece of equipment revolutionize the industry. Connector Detector detects missing and misaligned plates, improves production quality, and works with all existing truss equipment.

Lakeside Trailer Mfg., Inc.

See ad on page 40

Lakeside Trailer Manufacturing will be displaying two popular roll-off models. Since 1987, Lakeside has produced over 1700 trailers designed specifically for the wood component industry. With sales in all 50 states plus Canada, stop by our booth to see why Lakeside Trailer has become the industry leader in solving your delivering needs.

Contact: Mr. Lee J. Kinsman • 573/736-2966 • 573/736-5515
lee@rollerbed.com • www.rollerbed.com

Lignum Forest Products

Lignum Forest Products LLP is a distributor of lumber products focused on servicing Truss manufacturers. Lignum is a partner with Pope & Talbot and Tembec, both leading manufacturer of MSR. With strategically located reloads, we can service your needs in a timely manner.

LP Building Products

LP® SolidStart® Laminated Strand Lumber (LSL) is the ideal product for a variety of applications including metal plate connected trusses and tall wall framing. SolidStart LSL's consistency and predictable performance means no swelling, twisting, or buckling and its superior strength and uniform density provide the perfect solution for the lack of dimensional stability commonly found in most lumber; and it's available in lengths up to 64 feet to create taller walls and open ceilings and floor plans. LP SolidStart LSL is manufactured from smaller aspen and maple trees and is certified under the Sustainable Forestry Initiative (SFI).

Lumbermens Merchandising Corporation - LMC

LMC - BUILDING ON SERVICE® LMC is a not-for-profit purchasing cooperative owned by over 350 independent stockholders. Over 100 of our stockholders have truss/wall panel operations representing 140 manufacturing locations. Since 1935 we have leveraged volume to gain benefits unattainable to most businesses. We purchased near three billion dollars annually over the past few years. It is LMC's mission to be the preferred source to which stockholders can entrust their purchases of forest products, building materials and other related products and services.

Metriguard

The World's Leading Provider of precision equipment for: Machine Lumber Grading (MSR & MEL), Veneer Testing (LVL), Bending & Tension Testing (Quality Control) and Structural Panels (OSB & Plywood).

MiTek Industries, Inc.

See ad on pages 2-3

At MiTek we bring together software, machinery, connectors and services that work together sensibly to automate your component building process—from design concept to component engineering to final installation. Our associates are focused on a single purpose—your success. Come see the PLANX automated jiggling system along with new automated material handling, powerful structural modeling software and the people behind the product. We bring together a sensible and upgradeable approach to your business, providing a smart approach to enhancing your business performance. Come see how your success is now more than ever our success.

Contact: Mr. Michael Klein • 314/434-1200 • 314/434-5343
mklein@mii.com • www.mii.com

Monet DeSaw Inc.

See ad on page 64

We manufacture a variety of saws from simple push-button operation to top-of-the-line servo driven automated saws. On display this year will be the DeSawyer ES (servo driven saw), the FWA500 (floor web saw), and one of our linear saws. The DeSawyer ES is the highest production saw on the market and is by far every sawyers choice. It is the only saw in the industry with a complete manual backup system. Our FWA-500 continues to yield the highest productivity of any floor web saw available today. Please stop by our booth and we will show you the difference.

Contact: Mr. Kevin Troesser • 573/642-4900 • 573/642-3736
kevin@desaww.net • www.desaww.com

MSR Lumber Producers Council

See ad on page 20

The Machine Stress Rated Lumber Producers Council was formed to promote the benefits of Machine Stress Rated (MSR) lumber for the purpose of increasing the usage and acceptability of the product. It is the intent and mission of the Council to improve, promote, and advance the common interest and general welfare of all phases of the Machine Stress Rated lumber industry.

Contact: Ms. Kathy James • 888/848-5339 • 888/212-5110
msrlpc@msrlumber.org • www.msrlumber.org

KEY: Gold SBC Advertiser • Silver SBC Advertiser • Bronze SBC Advertiser • Asterisk (*) indicates a new exhibitor

Nordic Engineered Wood

Nordic Engineered Wood, a wholly-owned subsidiary of Chantiers Chibougamau, was founded in the year 2000 to develop and promote high quality wood products for use in residential and light commercial construction. Our vision is built on the founding principles of reliable service, consistent quality, and responsible forestry practices. Chantiers Chibougamau has achieved ISO 14001 accreditation, the international standard for environmentally responsible harvesting and reforestation, FSC certification is targeted for October 2008.

NUCONSTEEL

See ad on pages 27, 54-55

If it can be done in light gauge steel, NUCONSTEEL® can do it! NUCONSTEEL has developed an innovative, fast and, cost-effective method of producing cold-formed steel components for the residential market. With this NU WAY TO BUILD®, the NUFRAME™ and NUTRUSS 2.0® systems can help YOU produce panels and trusses on time every time! Stop by our booth to for live software demos and to see wall panels and trusses being produced in minutes. We have added six new products built by our systems...stop by and check out our new innovations.

Contact: Ms. Lindsey Rattan • 940/383-0593 • 940/383-7939
lrrattan@nuconsteel.com • www.nuconsteel.com

OptiFrame Software, LLC

Pacific Automation Ltd - MiTek

See a live demonstration of our quality truss manufacturing equipment at the BCMC 2008. Talk to us about the many machines in our product line, sold world wide.

Pacific Trail Mfg., Inc.

Crosscut unit saws (bunk saws) are extremely valuable tools in the truss industry. These saws quickly cut lumber back to easily handled lengths. Many truss manufacturers either have flexibility in bringing in longer length lumber or deal with "the only product available". Companies are then stuck with labor costs of cutting one board at a time or using a chain saw before down-line processing. (Feeding the component saws.) In approx. one minute, you can saw a unit of lumber to any length you wish with cutting tolerances of ±1/4", ±1/16" & ±1/32" to suit your individual needs.

Palfinger North America

Palfinger North America is a world class manufacturer of truck mounted knuckle boom cranes and forklifts. Used in many applications, we offer several models, which can be operated with radio remote control for fast and economical operation. Palfinger also offers the ideal solution for various loading and unloading problems encountered by transport operators. Different models of the Crayler truck mounted forklift are available depending on your specific needs. Palfinger and their distributors can help custom-manufacture a material handling system to meet your toughest challenges! For more information on the Palfinger product lines, please contact us at 800-567-1554.

Panels Plus

See ad on page 25

PANELS PLUS is the construction industry choice for wall panel equipment and accessories from framing and sheathing stations to full production lines. Our design engineers use state of the art hardware and software and have the ability to customize equipment to customer specifications and floor space. Panels Plus offers quality expandable equipment options for the low volume startup plants to quality equipment for the high volume manufacturing plants. This year at the BCMC show we are showcasing the CN100 Sub Component Nailer. It features finger tip setup operation to allow just in time flow. PANELS PLUS, helping build technology into your craftsmanship.

Contact: Mr. Tim Kaasa • 507/369-0507 • 507/373-7110
tkaasa@panplus.com • www.panplus.com

Pelican Bay Forest Products*

Pelican Bay Forest Products is a supplier specializing in Truss materials. Our traders are motivated and dedicated to establishing and managing relationships with their customers and suppliers. Our traders help their customers make lumber-buying decisions, analyze market conditions, and make recommendations to solve problems.

Pennsylvania Lumbermens Mutual Insurance Co.

See ad on page 18

PLM specializes in Property and Casualty insurance for the lumber, woodworking and building material industries. Established in 1895, we have over a century of industry knowledge and expertise. The company was formed "by lumbermen for lumbermen", and throughout our entire history, wood and the wood industry has been our sole focus. We offer competitive rates, loss control programs and prompt claims response and handling. We are financially strong and carry an A.M. Best rating of A (Excellent). For more information, contact us at 800-752-1895 or visit our booth to learn more about our services.

Contact: Ms. Charlotte Friend • 800/752-1895 • 215/625-9097
cfriend@plmins.com • www.plmins.com

PFP Technologies

See ad on page 39

PFP Technologies are the designers and manufacturers of the Razer linear saw and peripherals. Our version 5 saw is faster and even more robust and reliable than ever. Come and see the flexibility, versatility, and industry leading features of the Razer. Try the user-friendly but powerful software which includes optimization and real time length calibration. The Razer can be run on its own or fully integrated with optional automated in feed and out feed systems affordable for any size truss plant. We look forward to catching up with old customers and meeting new ones.

Contact: Mr. Joseph A. Tuson • +61/8 9 249 4542 • +61/8 9 249 4596
joetuson@pfpotech.com.au • www.razerusa.com

Popular Equipment Finance

Popular Equipment Finance (PEF) specializes in financing equipment for the building components manufacturing industry. PEF, a bank owned direct lender, was established in 1996 and is recognized as a "Top 50 Company" in St. Louis. PEF offers leasing and financing in all 50 states, Puerto Rico and the USVI with terms from 36 to 84-months, an application only program up to \$350,000 without financial statements, competitive rates and unrivaled customer service. We invite you to discover what makes us Popular.

Precision Equipment Mfg.

Precision Equipment Mfg. manufactures quality roll off trailers for easy, roll-off right to the ground delivery, all over the country and Internationally. Our goal is to be your trailer company, you may choose one of our standard series 40', 48' and 53', or our stretch trailers which come in 36'-51', 42'-60', 46'-64', 50'-70', 53'-80'. We also manufacture the HD series goosenecks that come in 28', 32' and 36' lengths. We can custom make any size or axle configuration that best suits your needs. We want to earn your business!

Princeton Delivery Systems Inc.

Princeton Delivery Systems located near Columbus is the leading U.S. truck mounted forklift manufacturer. Princeton offers four PiggyBack® Delivery System models designed for building material applications: The "4-Way" is specifically designed to carry long loads, like engineered floor joists, through narrow openings. PB80 will handle prefabricated wall panels or other heavy loads. It is the industry's lightest 8,000 pound capacity unit. PB50 5,000 pound capacity unit is unequaled in rough terrain performance. PB45 with 4,500 pound capacity is ideal for medium loads on many single axle trucks.

KEY: Gold SBC Advertiser • Silver SBC Advertiser • Bronze SBC Advertiser • Asterisk (*) indicates a new exhibitor

Qualtim, Inc.

See ad on page 58

Have you been considering ideas for improving your business and marketing approach but never seem to find enough time? As the industry leader in personalized service and support to the structural building components industry, Qualtim offers both creative and technical solutions. We provide website, advertising and other marketing expertise, online training creation and management, manufacturing and QC knowledge, engineering and expert witness support, as well as truss testing and product development assistance. Qualtim invites you to stop by our booth to discuss your marketing or technical needs and how we can serve you with expert, creative and affordable solutions.

Contact: Ms. Peggy Pichette • 608/271-1176 • 608/271-7006
ppichette@qualtim.com • www.qualtim.com

Randek BauTech AB

Randek BauTech AB is the world leading manufacturer of automated equipment components for producing prefabricated homes. Our equipment produces finished building components faster and more efficiently than any other manufacturer. Compared to competing technologies, our machines will produce up to four times the linear feet of wall panels per shift. Our leading-edge technology enables manufacturers to produce high quality wall and floor panels in the shortest possible time with a minimum number of operators. Since 2000, we have delivered 13 production lines in the USA and Canada. Randek Automated Equipment, Inc. is exclusive North American agent for Randek BauTech AB.

Rayonier Wood Products

Rayonier Wood Products manufactures high quality Southern Yellow Pine lumber, including the hard to find "Dense Select Structural" grade. Rayonier is a value-driven, service focused company. Our production facilities give us the flexibility to offer customers the highest quality products for use in construction, remodeling and decorative applications. Please visit us at the show to meet our staff and learn more about us and our products.

Rex Lumber LLC & North Florida Lumber

Rex Lumber and North Florida Lumber are two of the Florida's top sawmills. We make some of the best Southern Yellow Pine. We also make many different truss grades.

Robbins Engineering, Inc.

As a member of the family of MiTek Industries companies, the industry leader in personalized service and support we continue to provide a complete software solution for the component industry. Robbins Engineering is known as the developer of one of the industry's most intuitive, comprehensive, and integrated software, Online Plus™ layout and engineering (CAD/Cam) software, InfoStar™ management information software, and Wallstar™ wall panel software. Robbins Engineering offers Web Based Software training 24/7. Robbins invites you to see all of our other products the MiTek family has to offer.

Robbins Lumber

Robbins Lumber offers distribution centers throughout the Midwest specializing in MSR Pine and MSR spruce lumber. We have office locations in Florida, Michigan and Chicago, IL. Stop by our booth and let us show you our commitment to customer satisfaction.

SBC Research Institute (SBCRI)

SBCRI provides thorough, affordable testing of construction products with the goal of developing a better knowledge of actual performance, both alone and within the integrated structure. Offering complete confidentiality to independently evaluate any type of innovative product or product system, SBCRI has an extensive list of testing options under a variety of application, attachment and loading conditions. Dedicated to the fact-based analysis of component performance and properties, SBCRI testing will lead to more accurate and efficient design and improved installation—advancing a new generation of growth for the structural building components industry.

Senco Products, Inc.

Pneumatic, battery and electric-operated stapling, nailing, and screw systems equipment and collated fasteners for all areas of the industry.

Simpson Strong-Tie

See ad on page 21

Simpson Strong-Tie Company is the world's largest manufacturer of steel connectors for wood construction. The product line totals nearly 7,000 items, with more than 1,700 different joist hangers alone. Strong-Tie® connectors for solid timber, composite wood products and plated trusses are the most specified of any brand. Simpson leads the industry in retrofit connectors for seismic and high-wind protection. The Simpson Steel Strong-Wall® shearwall is ICC listed (ESR 1679), available in 12" to 24" widths, and is the strongest shearwall on the market today.

Contact: Ms. Frankie Emerson • 925/560-9000 • 925/847-1603
femerson@strongtie.com • www.strongtie.com

SL-Laser Systems

See ad on page 20

Founded in 1988, SL Laser has been a pioneering force in the development of precision single and multiple head laser projection systems for truss, floor deck and wall panel systems. Our patented hardware and state-of-the-art software feature many user-friendly features designed to enhance functionality, while prompting the easy-to-use fundamentals that make our systems the industry benchmark. Seamless integration between TrussPilot™ software and hardware results in reduction of production costs and an increase in accuracy and profitability. Our Laser Systems can be found projecting increased productivity in some of the finest building components manufacturing companies in the world.

Contact: Mr. Jason Galek • 704/561-9990 • 704/561-9994
jgalek@sl-laser.com • www.sl-laser.com

Southern Pine Council

See ad on page 17

Southern Pine is the #1 species used by component manufacturers. A big reason is Southern Pine saves money due to its high strength, stiffness, and density. Southern Pine is available in strong visual grades, plus MSR and MEL, making it ideal for roof and floor trusses. Finger-jointed studs also provide a strong, straight product for wall panels. Come check out our new Structural Components brochure.

Contact: Ms. Catherine M. Kaake, P.E. • 504/443-4464 • 504/443-6612
ckaake@sfpac.org • www.southernpine.com

SpaceJoist TE, LLC -

ITW Building Components Group

Capture a growing market with the GENUINE INNOVATION of SpaceJoist TE, LLC's Trimmable End products. The GENUINE INNOVATION ranges from the SpaceJoist TE floor trusses to Insert TEs. We have an option to fit your needs! Stop by our booth to see how these INNOVATIVE products can benefit your company.

SPIDA MACHINERY

SPIDA designs and manufactures a range of industrial saws and tables specifically for the TRUSS and FRAME industry. Our AUTOMATED sawing systems can help your plant reduce errors and increase quality and production of components—saving you valuable time and money. SPIDA's range of machinery will provide years of accuracy, reliability and low maintenance. SPIDA saws are known for their exceptional quality and reliability. We look Forward to seeing our old friends and meeting new ones this year.

Spotnails

Spotnails has been one of the leading manufacturers of pneumatically driven fasteners for nearly 70 years. The Company manufactures a wide range of industrial fastening products including nails, staples, pins, brads and tools for use in packaging, furniture/woodworking, construction, factory-built housing and many other industries. With manufacturing facilities in the United States, Mexico and Korea, Spotnails is keeping pace with the demand for quality tools and fasteners.

KEY: Gold SBC Advertiser • Silver SBC Advertiser • Bronze SBC Advertiser • Asterisk (*) indicates a new exhibitor

Stanley-Bostitch

Stanley-Bostitch manufactures a full line of nailing and stapling tools for adaptability to automated wall panel/component equipment (high load tool capabilities). We also offer a loan tool and on-site service program, as well as automation support.

Stiles Machinery Inc.

See ad on page 57

Weinmann offers a complete range of machinery for the efficient and economical production of frame wall, SIP wall, floor, and roof components including assembly and tilt tables, automatic framing stations, and automatic fastening with nailing, stapling, and screw driving equipment. Weinmann features fully-automated CNC processing with their unique multi-function bridge machines, and WBZ lumber saws and machining centers. Stiles Machinery, Inc. is pleased to sell and service Weinmann component manufacturing systems in the USA. Weinmann is represented in Canada by Homag Canada.

Contact: Mr. Tom VanSlooten • 616/698-7500 • 616/698-9411
 tvanslooten@stilesmachinery.com • www.stilesmachinery.com

Structural Building Components Magazine

Your Industry...Your Ideas...Your Magazine! *Structural Building Components (SBC) Magazine* is the component industry's primary resource for leading-edge information about current issues, trends and products that affect the future of framing. The mission of *SBC* is to increase the knowledge of and to promote the common interests of those engaged in manufacturing and distributing structural building components. *SBC* strives to ensure growth and continuity and to be the industry's information conduit by taking a leadership role in the dissemination of technical and marketplace information. *SBC* staff welcomes your feedback and article ideas at editor@sbcmag.info.

Summit Forest Products Inc.

Summit Forest Products Inc. is a North American distributor specializing in the supply of lumber to component manufacturers. Through our strategically placed distribution centers we have the ability to service truss manufacturers throughout the United States & Canada, with high quality lumber at a level of service that is second to none. Whether it is quick delivery, highly specified tallies or forward pricing, at Summit we adapt to the individual customers' requirements. We continually strive to understand and anticipate our customers' needs to ensure that we are supplying them with well priced, high quality products.

SUNBELT

Sunbelt has provided quality steel storage systems to lumber yards and building materials dealers nationwide since 1987. We specialize in designing, engineering and installing warehouse racking, rack supported buildings, T-sheds and bulk sheds. Sunbelt offers complete yard and warehouse planning services tailored to each customer's specific needs, along with multiple ship points. Visit our booth to discover the many ways Sunbelt can be beneficial to your business.

The Hain Company

See ad on page 38

The Hain Company specializes in developing machinery and solutions for the lumber and truss yards, onsite framing, wall panel, shed manufacturing as well as TJI processing and any other random length cutting or precut packaging. With 30 years of experience helping this industry provide for production needs our products reflect machinery that works for you. This gives you the consumer an advantage to not only produce an efficient product but will reflect money well spent. The Hain Company builds machinery that is built to last. The Hain Company also broker's Klaisler—Monet DeSaw—Mango—Maximizer Technologies and Koskovich.

Contact: Mr. Leonard Hain • 530/295-8068 • 530/295-0468
 leonard@haincompany.com • www.haincompany.com

The Koskovich Company

See ad on pages 29, 61

The Koskovich Company manufactures automated equipment for cutting, marking, handling, and assembling wood roof truss and wall frame components. The Miser™ single blade linear feed saw with material handling systems is a one-man operation. Its ink jet marking system speeds up assembly of roof truss and wall frame components. It performs most any angle cut, including compound angles, rip and bevel cuts, as well as infinite-length scarf cuts. Planx™ automated roof truss jiggling system cuts jiggling time to 30 seconds. It can be installed on new truss assembly tables from MiTek® and other manufacturers, or retrofitted to most existing tables.

Contact: Ms. Karin Anding • 507/286-9209 • 507/285-1730
 karina@omnisaw.com • www.KoskovichCompany.com

Timber Products Inspection

Todd Drummond Consulting, LLC.

Professional Lean Manufacturing Consulting Services for the Component Industry. Including time standards for truss fabrication labor estimation. (Man-minutes, R.E. & S.U.) Normal Payback is 3 to 4 months! Truss Shop Labor Tracking Software Systems for truss fabrication. Track every man and order in your shop down to the minute. Consulting services tailored to your needs. Proven and practical solutions using Lean Manufacturing and Theory of Constraints principles for your component manufacturing. Clear and practical ideas that you can implement into your organization that can make a difference.

Triad/Merrick Machine Company

See ad on page 34

As one looks back through the history of component homes and reviews the advancement in technologies, one name remains synonymous: TRIAD. During FIVE decades Triad panel, component, floor and stair machines have lead the industry in meeting the needs of builders in the US, Canada, and around the world. Having built more panel equipment than all of the competition, COMBINED, Triad continues to meet the ever growing needs of today's builders by providing machinery and production systems that: lower labor, give higher production & productivity, controlled material costs, high quality finished products, and the latest state-of-the-art engineering.

Contact: Mr. Lanny Morris • 800/568-7423 • 308/384-8326
 lannym@merrickmachine.com • www.triadravo.com

Trim Fit, LLC

See ad on page 35

Trim Fit LLC manufactures the I-Block, an insert able, plate-able end panel component for your open web floor truss program. The Trim Fit I-Block is made of solid sawn, southern yellow pine. I-Block inserts are trimmed to 16" in length and are manufactured in truss depths from 11-1/4" to 24" in both 4x2 and 3x2 chord widths. On the job, the I-Block allows for maximum trim of 12". Save time in design and production, meet job deadlines and increase customer satisfaction.

Contact: Mr. Joseph E. Voss • 573/437-4848 • 573/437-4848
 iblocks@trimfitllc.com • www.trimfitllc.com

Truss Plate Institute

The Truss Plate Institute (TPI) and its members are connecting the truss industry. Come visit the TPI booth to see how and to learn more about the products and services provided by TPI. Speak to our professional staff about our nationally recognized quality assurance inspection program. Learn about the recently released ANSI/TPI 1-2007 standard. Review and ask questions about other guidelines and technical publications such as BCSI. See you at the show!

TrusSteel - ITW Building Components Group

TrusSteel® pre-engineered Cold-Formed Steel trusses from ITW Building Components Group, Inc. are the culmination of over fifty years combined experience in truss and Cold-Formed Steel building products. The product is built upon extensive truss engi-

KEY: Gold SBC Advertiser • Silver SBC Advertiser • Bronze SBC Advertiser • Asterisk (*) indicates a new exhibitor

neering and software knowledge inherent in Alpine products, an experienced staff of CFS design engineers and many years of designing and building efficient trusses. TrusSteel products simplify the processes of design, specification and inspection. Integral stiffness and a high strength-to-weight ratio make them easy to handle during installation. A nationwide network of local TrusSteel fabricators provide truss designs, details, specifications, construction hardware, estimates and finished trusses.

Truswal - ITW Building Components Group

See ad on page 32

Discover how you can put Truswal's genuine innovation in whole-house design (IntelliBuild™), engineering (TrusPlus™), plant efficiency (WinBatch™), plant management (TrusManager Pro™) and state-of-the-art equipment to work for you. These dependable tools combined with new features and enhancements in Truswal products will bring more speed, accuracy and reliability to your operation. See a demo to experience the innovation!

Contact: Mr. Ken Kuehn • 817/633-5100 • 817/652-3079
 kkuehn@itwbcg.com • www.truswal.com

Turb - O - Web

See ad on page 28

The Turb-O-Web™ System. The Turb-O-Web System delivers efficient truss manufacturing by standardizing webs. The two key elements of the system are both ready at MiTek, namely 1. The MiTek 20/20 Truss design software with the Turb-O-Web features enabled, and 2. MiTek Elipsaw for cutting standard Turb-O-Webs at about 3x the speed of any other web saw and at about 1/3rd the cost. Standardization of parts is key in all manufacturing industries, and the roof truss business is no exception. The Turb-O-Web System increases total plant capacity and a simultaneously reduces unit cost, improving the plants competitive edge in this difficult market.

Contact: Mr. John Griffith • 888/750-6005 • john@turb-o-web.com • www.turb-o-web.com

USP Structural Connectors

USP Structural Connectors is a metal fabricating manufacturer serving residential and commercial building industries throughout the United States and Canada. USP's product line encompasses over 4,000 finished part numbers: standard construction hardware for the light construction and retail/do-it-yourselfer markets, as well as a complete line of connectors for the Engineered Lumber and Plated Truss industries. This full-range product line is backed up by an in-house engineering staff, technical assistance team and Customer Service. USP products are manufactured in four locations across the United States: Minnesota, Florida, California and one in Canada.

Viking WPS

See ad on page 59

Viking has provided creative fastening and material handling solutions to worldwide markets for over 30 yrs. Our history and experience has allowed us to create a line of new wall panel assembly products that clearly differentiate us from anything on the market today. All Viking equipment runs independent of design software and allows you to choose or change to any design software that fits your business needs. Our modular approach allows you to start small and increase production later by upgrading and adding equipment that moves your line from manual to a fully automated solution.

Contact: Ms. Linda Resch • 800/328-2403 • 763/571-7379
 lindar@vikingeng.com • www.vikingeng.com

Virtek Vision International, Inc.

Virtek is the leading developer of precision laser-based solutions enabling component manufacturers to produce products faster, better and at lower costs. The Virtek TrussLine Laser Projection System, with new green lasers that provides improved visibility with new software that features improved usability, real-time production status, and reporting functionality. The LaserMC, laser marking system has no ink mess or consumables. It streamlines the production of component

materials used in wall panel assembly by measuring, laser marking and cutting in a single step. Virtek I-Joist Processing precision cuts I-joists with optimization of material and automatically routes service openings.

Vision Financial Group, Inc.

VFG is a one-stop leasing & financing source for all of your equipment needs. Whether you are a vendor looking for ways to improve your sales cycle or a user of equipment looking for a competitive source of financing, Vision can meet your requirements. Vision provides a full range of terms and structures and is not limited by equipment, cost or location. Leasing can improve your bottom line, preserve cash and improve your cash flows. Vision Financial, headquartered in Pittsburgh since 1991, has satellite offices in greater Atlanta and Charleston. Our national toll free number is 888-834-3278.

Wasserman & Associates

See ad on page 28

Wasserman & Associates is a representative for new truss, wall panel, stair, door and material handling equipment. We also offer the option of used or reconditioned equipment. As a partner in your equipment selection process, we promote the equipment that best suits your individual requirements, not the equipment that optimizes our commission. Buying or selling, large or small budget, please contact us.

Contact: Mr. Rod Wasserman • 402/438-2161 • 402/438-2524
 rodwass@aol.com • www.wasserman-associates.com

West Fraser

With more than 15 sawmills in British Columbia, Alberta, and most recently, the Southern United States, West Fraser takes pride in being a preferred supplier to both domestic and global clients. Collectively, West Fraser operations supply the world with more than 2.6 billion FBM of lumber annually. West Fraser produces a variety of softwood lumber products which are sold into the North American and export markets. We are committed to producing and delivering a quality product and, as such, take steps to ensure standards are consistently met. All lumber is graded in compliance with the National Lumber Grades Authority.

Contact: Mr. Barry Bauman • 800/841-2507 • 901/620-4204
 barry.bauman@westfraser.com

Wood Truss Systems, Inc.

See ad on page 58

USED AND NEW EQUIPMENT—Fully independent, we search from top suppliers for equipment and services that best meet your needs. We've built our reputation on it. WTS is known for delivery of innovative and objective solutions plus service that consistently places us among the top sales representatives in North America. You can count on effective and economical solutions featuring new and used: Truss and Wall Panel Equipment, Automated Saws: Component, Radial Arm, Measuring Systems, Material Handling Systems, Automated Jiggling Systems, Waste Reduction Equipment, Replacement Production Surfaces & Plant Layouts/ Production Consulting.

WTCA - Representing the SBC Industry

See ad on pages 8, 15

WTCA is a leading force in strengthening the structural building components industry. Representing component manufacturers, builders, material suppliers and industry professionals, WTCA provides the tools and resources needed to grow component manufacturing businesses. Whether it's educational resources, risk management strategies, building code watch, financial/wage surveys, legislative alerts, in-plant safety and quality control, transportation issues, technical training or marketing plans, WTCA provides tangible benefits. Stop by our booth to learn about the SBC Research Institute, get a first-hand look at new and updated products and services, and see how it pays to be a member of WTCA.

Contact: Ms. Anna L. Stamm • 608/274-4849 • 608/274-3329 •
 astamm@quallim.com • www.sbcindustry.com

TOP CHORD CLUB MEMBERS & AWARD WINNERS

[Current as of August 12, 2008 • Asterisk (*) indicates attainment of a new membership level in 2008.]

Diamond Club

Mr. Staton Douthit	124
Mr. Leonard Sylk	115
Mr. Norm McKenna	103
Ms. Nancy Matousek	99
Mr. Gary L. Weaver	72
Mr. Koss Kinser	70
Mr. John R. Herring	69.5
Mr. Richard W. Brown	68.5

Mr. Eric Lundquist	67
Mr. Dale Fenton	66
Mr. Merle Nett	62
Mr. Rip Rogers	56
Mr. Joe M. Odgers	55
Mr. William Alcorn	54
Mr. Stanley K. Sias	54
Mr. Richard Terbrock	54

Lifetime Members

Mr. Keith Azlin	39
Mr. Ben Doyle	38
Mr. Don Hershey	37
Mr. Robert L. Ward	37
Mr. Lee Vulgaris	36.5
Mr. Kenneth M. Cloyd	33
Mr. Roger L. Montgomery	33
Mr. Dwight Hikel	30

Mr. David H. Imming	30
Mr. Michael L. Ruede	30
Mr. Glenn Traylor	30
Mr. Thomas F. Whatley, II	30
*Mr. Jack Dermer	29
Mr. Gifford M. Shaw	27
Mr. George Ketchum	26
Mr. Charles B. Montgomery	26

*Mr. Jerry Vulgaris	25.5
Mr. William H. Eber	25

New Members

Mr. Tom Lambertz	16
Mr. Don Ball	15

WTCA Hall of Fame

Each year at BCMC, WTCA inducts a new member(s) into the Hall of Fame. Each recipient is selected for this honor by the vote of industry peers and is recognized as contributing significantly to the advancement of WTCA and the component industry. Members include:

<u>1986</u>	Staton Douthit	<u>1996</u>	Lee Vulgaris
	Dr. Stanley K. Suddarth	<u>1997</u>	Kirk Grundahl
<u>1987</u>	Dave Chambers	<u>1998</u>	Bob Ward
	Don Percival	<u>1999</u>	John R. Herring
<u>1988</u>	Don O. Carlson	<u>2000</u>	Thomas J. Manenti
<u>1989</u>	Leonard Sylk	<u>2001</u>	Bernie Boilen
	George Eberle	<u>2002</u>	Koss Kinser
<u>1991</u>	John Mannix	<u>2003</u>	Merle Nett
	Bill Alcorn	<u>2004</u>	Richard Brown
<u>1992</u>	Rip Rogers		Andy Schwitter
<u>1993</u>	Tom Carbeck	<u>2005</u>	Suzanne Grundahl
<u>1994</u>	Michael Conforti	<u>2006</u>	John Meeks, P.E.
<u>1995</u>	Don Hershey		Kent J. Pagel
	Bill McAlpine	<u>2007</u>	Michael Ruede

Bowman Industry Enthusiast Award

Awarded each year at BCMC to an individual supplier member of WTCA who has enthusiastically supported the structural building components industry.

Award winners include:

<u>2005</u>	Michael Bugbee
<u>2006</u>	Thomas Manenti
<u>2007</u>	James Kent "JP" Pruitt

SBC Industry Leadership Award

New in 2006, this award honors an individual who, since the industry was founded 50 years ago, has helped nurture, support and grow the structural building components industry as a whole with their vision, innovation and/or creativity. The individual may be a component manufacturer, supplier, associate or any other person whose efforts has helped create our industry into what it is today. Recipients include:

<u>2006</u>	Abner Yoder • Stark Truss Company
<u>2007</u>	Charles Vaccaro • ITW (Alpine)

Attend the WTCA Annual Meeting on Thursday, October 2, to see who this year's award winners will be!



NOTHING COMPARES

Manitou Truck Mounted Forklifts

Now offering exceptional flexibility and productivity with the NEW Manitou bi-directional!

Doubling as a truck-mounted forklift and a yard truck, this 5,500 lb. capacity forklift is equipped with a long boom for unloading from one side and 2 way driving modes for access into tight spots.

For further information, please contact:
Manitou North America
800-433-3304 www.manitou-na.com



The World's Largest Manufacturer of Rough Terrain Lift Trucks

Over 250,000 Units Sold Worldwide

For reader service, go to www.sbcmag.info/manitou.htm

How to get from good to best!

Visit the EIS Booth at BCMC 2008

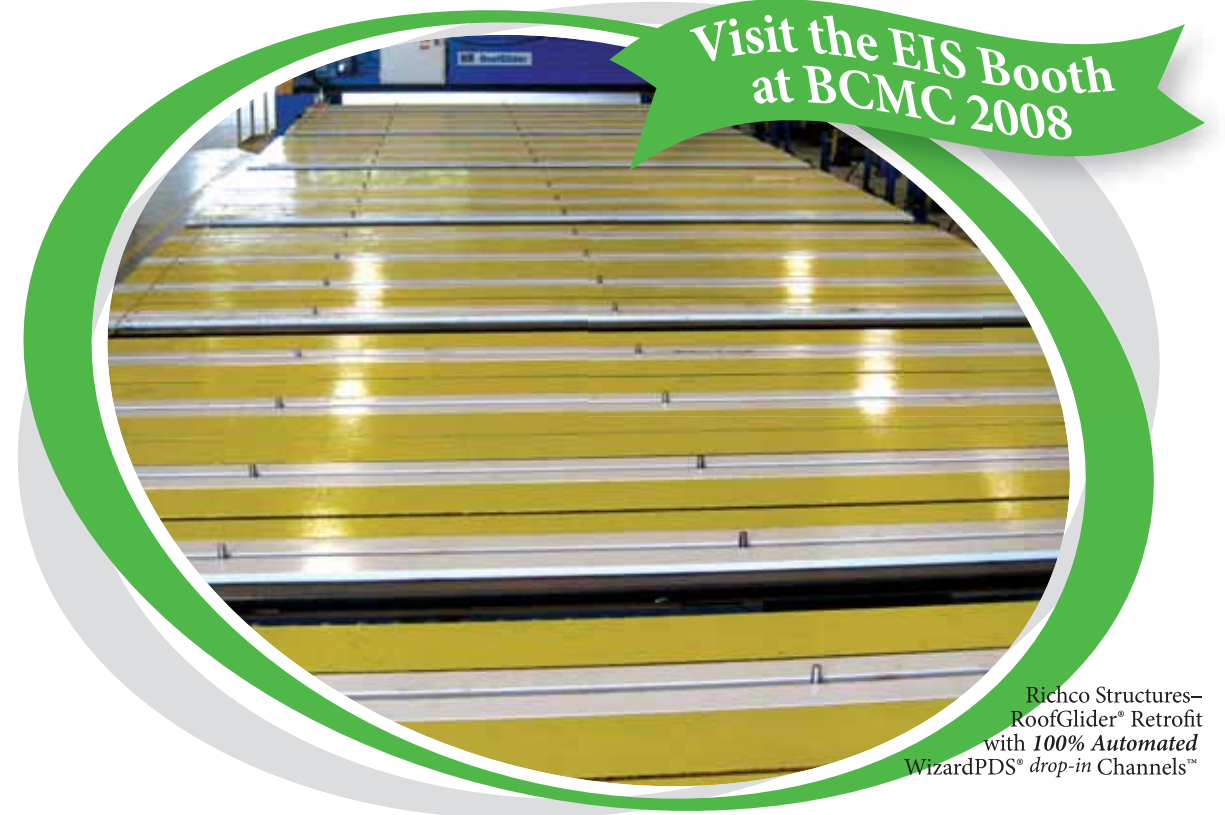

Richco Structures—RoofGlider® Retrofit with 100% Automated WizardPDS® drop-in Channels™

Retrofit WizardPDS® drop-in Channels™ to your existing press system— *Your machine at its best!*

The only system with the patented Open Channel design • Reduce set up time 99% • Eliminate ALL manual jiggling • Improve product quality 100% • Decrease labor • Increase output — WizardPDS® drop-in Channels™ are simple by design, reliable, dead-on accurate and come with 100% customer satisfaction.

When is the best time to retrofit? Right now! — and watch it pay for itself in just 6 Months! Visit our website or contact us today.
www.eideintegratedsystems.com • Toll-free 1-800-344-3433

— Visit BCMC for a sneak-peek at the latest innovations with the WizardPDS!

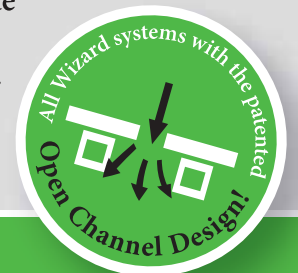

WizardPDS®
Automated Perimeter Definition System

EIS Eide Integrated Systems, LLC

We bring the best together!

Toll free 800-344-3433 Ph. 612-521-9193 Fax 612-521-9307 www.eideintegratedsystems.com
Eide Integrated Systems, LLC PO Box 11397 / 3219 North Second Street Minneapolis, MN 55411-0397

RoofGlider is a registered trademark of MiTek

For reader service, go to www.sbcmag.info/eide.htm



If you can imagine it, we can help you build it.

An imagination knows no bounds. And neither do we. If you can imagine it, we can help you build it. It's this unwavering conviction that has made us the most innovative steel company in the world. Our state-of-the-art design software can help you realize your wildest imaginings. From design right through to finished works of art, it does it all. All you have to do is have the courage to dream.

NUCONSTEEL[®]
A NUCOR COMPANY

Innovations in steel

For reader service, go to www.sbcmag.info/nuconsteel.htm. See additional ad on page 27.



Chapter Corner

For more information about WTCA Chapters and how to become more involved, contact Anna L. Stamm (608/310-6719 or astamm@quallim.com) or Danielle Bothun (608/310-6735 or dbothun@quallim.com). Contributions to Chapter Corner, including pictures, are encouraged. Submissions may be edited for grammar, length and clarity.



Chapter Spotlight

Educating Designers with the Michigan Chapter

by Anna L. Stamm

Marketing trusses directly to your potential buyers is one way to increase the acceptance and use of structural building components. But there is another way to increase market share—reaching out to building designers to demonstrate the benefits and ease of using components. So, how can your chapter reach out to designers? Why not try the Michigan example!

The Michigan Chapter is providing its members with customized binders of WTCA publications that have been specifically selected for the building design community. Members are able to hand-deliver or ship the binders to the architects, structural engineers and residential designers that they contact. The binders contain copies of the JOBSITE PACKAGE, *BCSI*, *Metal Plate Connected Wood Truss Handbook*, the design responsibilities document, and of course a list of chapter members. A cover letter explains that assistance is only a phone call away, so building designers are encouraged to contact chapter members for more information. The best part is that chapter members only have to pay the cost of shipping the binders—the chapter is providing the binders for free to all members.

This approach is excellent for any chapter that would like to add a personal touch to their marketing, provide a substantial package of structural building component-oriented publications, and reach out to all building designers. After all, the more information that architects, engineers, residential designers and specifiers receive on our industry's products, the more they will be inclined to use structural building components to create economical framing solutions for their customers. It's a win-win! **SBC**

Chapter Highlights

Iowa Truss Manufacturers Association

Despite the Midwest flooding, the Iowa Chapter held its summer meeting and golf outing in June. The day began with a plant tour of Engineered Building Design in Washington, IA. Thanks were extended Dave Mitchell and the employees of Engineered Building Design for the tour of the recently completed, and very impressive, truss manufacturing facility that contributed to more than 25 chapter members in attendance.

Following the tour, the meeting was held at the Washington Golf and Country Club. Ray Noonan gave the Education Committee Report. Andy Green and Al Esch presented a Fire Performance of Wood Trusses Workshop to the Monticello, IA volunteer Fire Department in March with

favorable evaluations. Given industry economics, however, the chapter will not seek further education opportunities this winter, but it will consider any requests as they arise.

Under new business, several items were discussed. The importance of attending BCMC was emphasized. Information from the Cedar Rapids HBA, "The Evidence Is In: Housing Pays for Itself," was distributed by Mike Farr and discussed. Also, a special recognition was made of Rick Terbrock who is retiring and was present for his last chapter meeting. Best wishes, Rick!

The afternoon of golf was enjoyed by most all who attended the tour and meeting. A special thank you was extended to the associate member sponsors. Rick Terbrock of MiTek Industries and Leonard Wasserman of Wasserman & Associates provided hole sponsorships. Prizes were contributed by Ted Alward of USP Structural Connectors, Josh Fitzgerald of Simpson Strong Tie, and Kari Cooling and Jim Kapsch of Holmes Murphy & Associates.

West Florida Truss Association

The West Florida Chapter continued to support the Give Kids the World charity this year. At the June membership meeting, it was reported that help was needed on five more villas. With an overall goal of 21 sets of trusses, they already had commitments of support (trusses, materials or monetary donations) from several chapter members: 41 Truss, Florida Forest Products, Kimal Lumber Company, Stock Building Supply, West Coast Truss, ITW Building Components Group, MiTek Industries and Simpson Strong-Tie Co.

The presentation at the June meeting was given by Kari Hebrank. With an update on everything to do with construction and Florida politics, Kari spoke on several topics. Regarding the Florida Building Code (FBC), she noted that the code language was changed under the "code plus" designation to no longer reference a 500-year storm event. She also commented on code changes for re-roofing, and noted that the effective date for the FBC had been moved to December 31, 2008. Kari also provided information on green building, specifically LEED and Green Globes. The members thanked her for her informative updates and interesting discussion.

Plans for the fall event were finalized at the July chapter board meeting. The 23rd Annual Building Officials Event will be held on November 7 at Robbins Engineering/MiTek Industries in Tampa. In addition to testing a field-repaired truss, the attendees will be able to earn continuing education credit for "Inspection of Installed Wood Trusses," a Truss Technology Workshop (TTW) from WTCA. Engineers from MiTek and ITW will deliver the presentation along with Robert Wall, PE of Architectural Services & Engineering. Sponsors for the event include: iLevel by Weyerhaeuser, ITW Building Components Group, Robbins Engineering/MiTek Industries, Simpson Strong-Tie Co., Structural Connections, Inc. and USP Structural Connectors.

Southern Nevada Component Manufacturers Association

At the July meeting, the Southern Nevada Chapter's Code Committee

Continued on page 58



sensible

When you invest in machinery you require a return on your investment. Weinmann automated production solutions from Stiles Machinery deliver on that return with the promise of a sensible investment. In today's market, automated solutions are providing panel and truss manufacturers the ability to remain competitive with the flexibility to grow as their business requires. Stiles and Weinmann offer the proven machinery design and implementation experience you expect from the leaders – a partnership that will quickly impact your bottom line and return on investment. Learn more about how to employ the promise of sensible automation.

For more information, contact Michael Miller, Director of Building Automation, at 616.698.7500 or mmiller@stilesmachinery.com or visit www.stilesmachinery.com.



See us at



WHP 100 Robotic Material Handling Portal

- Automatically retrieves raw materials and feeds saw
- Takes one man operation to the next level
- Increases machine availability and parts per shift output



WBS 120-High Speed Linear Sawing Machine

- Engineered for the complete range of cutting and marking required by today's truss and panel manufacturer.
- Ability to handle material in excess of 40'



Truss and wood component machinery experts for over 30 years. We can help you enter the component industry or refine your existing facility with custom equipment solutions featuring:

New & Used

- ▲ Truss Production Equipment
- ▲ Wall Panel Framing Equipment
- ▲ Automatic & Manual Cutting Equipment: Component, Radial Arm, Linear Single Blade Saws
- ▲ Plant Layouts / Production Consultants
- ▲ Automated Jigging Systems
- ▲ Automated Measuring Devices
- ▲ Replacement Production Surfaces

Count on effective, economical and timely solutions.

www.WoodTrussSystems.com

888.288.WTSI (9874)



For reader service, go to www.sbcmag.info/wts.htm.

Peace of mind underfoot

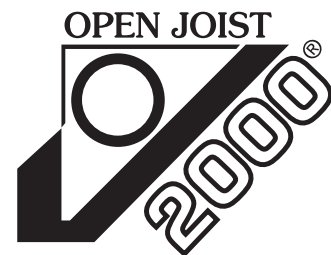

Reengineering Wood Components

www.openjoist2000.com

(800)263-7265

mike@openjoist2000.com

For reader service, go to www.sbcmag.info/openjoist.htm

Where *right brain* meets *left brain*.

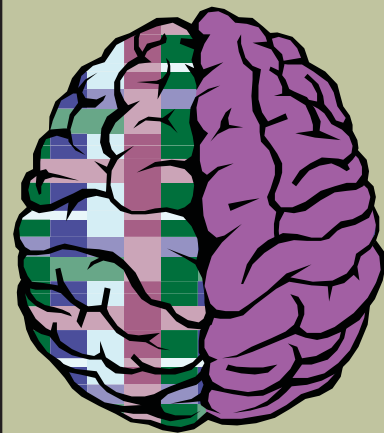

See you at **BCMC!** www.qualtim.com

For reader service, go to www.sbcmag.info/qualtim.htm

Chapter Corner

Continued from page 56

Co-Chair Rich Menge, PE, reported that the local building departments remain in the same status with the City of Las Vegas having only one plans checker and express plan check remains in effect for residential buildings up to 5,000 square feet. The city has further reduced its staff to a total of four building inspectors. The City of North Las Vegas interim senior building official remains subject to change every 30 days between officials within the department.

The flat growth rate in Las Vegas was discussed next. The Las Vegas Housing Market monthly newsletter reported that 884 permits were issued in June, making a total of 3,628 for 2008, resulting in a decrease of 61% from 2007. The estimated total for 2008 was given at 8,200, the lowest since the mid-1980s. The median new home price of \$269,900 was down 16.7% from 2007. Some 65% of closings in June were bank-owned properties. Directly then the resale market has an adverse affect upon the new home market. According to the report, this trend would likely continue through 2008 and into 2009.

The chapter welcomed its newest member, Desert Truss. All members were encouraged to attend the upcoming BCMC show in Denver, CO. Also, the date of the fall meeting was confirmed for October 16, but the location may be changed to a more convenient restaurant.

WTCA - Indiana

The Indiana Chapter held its first golf tournament and membership drive in July. Beautiful weather and great players combined for a terrific event. On the winning golf team were Don Simon of Nordic Engineered Wood, Ed Winders of Contract Lumber, Jay Bunyard of Wood Truss Systems and Brad Emmert of Timberland Lumber Company (see photo). In addition, there were two contests, sponsored by Nordic Engineered Wood and MiTek Industries. Winning the longest drive competition was Shawn Pell of Timberland. The prize for closest to the pin went to Jay Bunyard. Hearty thanks were given to MiTek and Nordic for sponsoring the contests, to the three hole sponsors—Pennsylvania Lumbermens Mutual Insurance, iLevel and Weyerhaeuser—and to Simpson Strong-Tie Co. for door prizes. Special thanks were also given to the golf committee, Brad Emmert and Ed Winders, for doing such a great job putting the event together. **SBC**

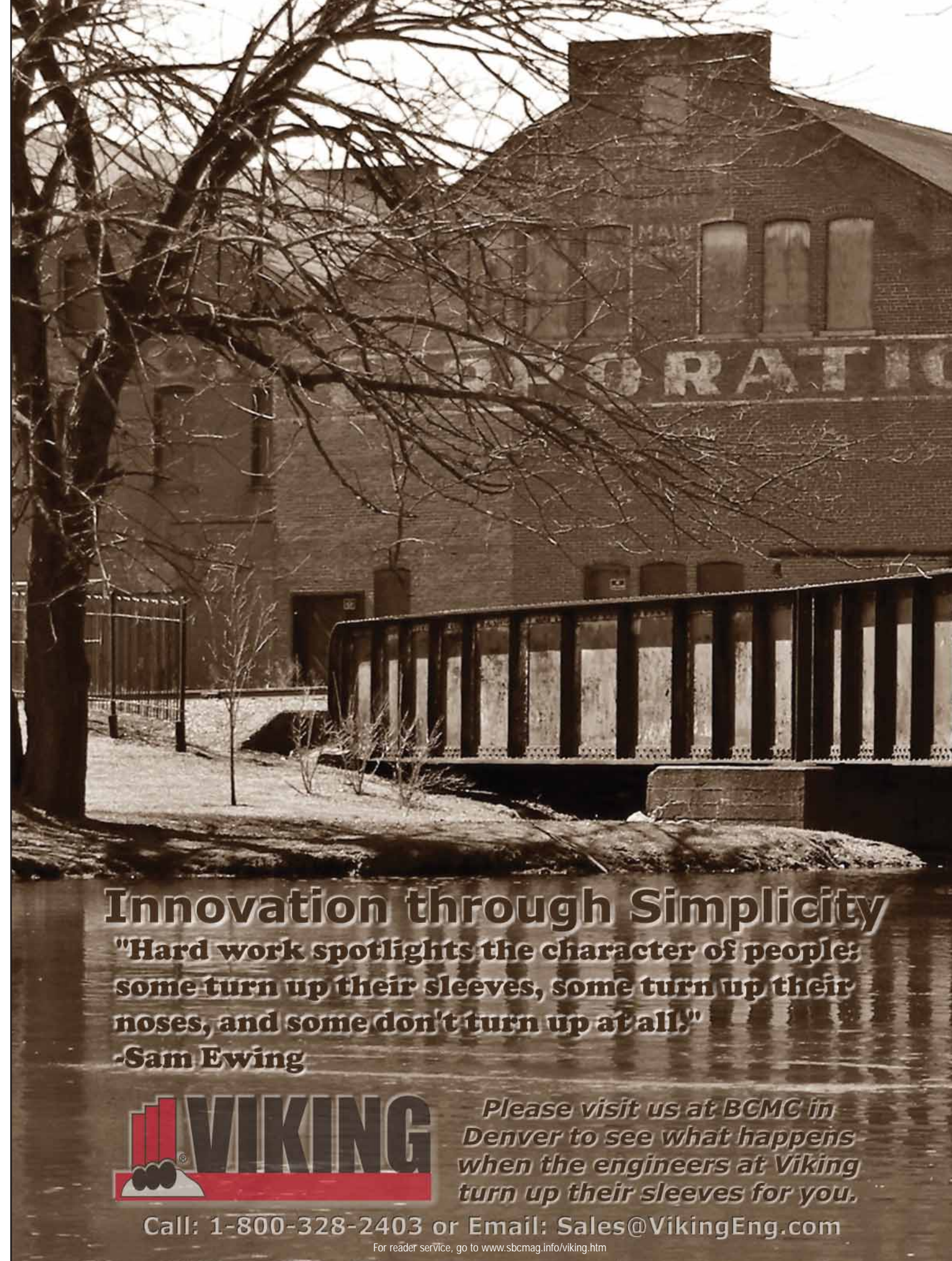

Innovation through Simplicity

"Hard work spotlights the character of people; some turn up their sleeves, some turn up their noses, and some don't turn up at all!"

-Sam Ewing



Please visit us at BCMC in Denver to see what happens when the engineers at Viking turn up their sleeves for you.

Call: 1-800-328-2403 or Email: Sales@VikingEng.com

For reader service, go to www.sbcmag.info/viking.htm

**Considering equipment?
Consider Clark.**

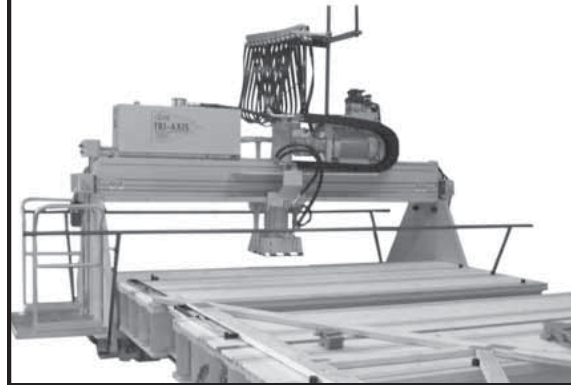

- Roof & Floor Truss Presses
- Multi-Head Truss Presses
- Modular Truss Presses
- Shuttle Presses
- Jack Presses
- H.D. Chord Splicers
- Floor Truss Machines
- Electric Horizontal Stackers
- Electric Peak-up Stackers
- Post & Column Machines
- Conveyor Systems
- Custom Machinery

Call us toll free at: 800.743.9727, or visit us on the web at www.clark-ind.com

For reader service, go to www.sbcmag.info/clark.htm. See additional ad on page 13.



Calendar of Events

Check out www.sbcindustry.com/calendar for the most current calendar information and complete event details.

September

- **18:** South Florida WTCA (SFWTCA) Chapter Meeting.
- **18:** Truss Manufacturers Association of Texas (TMAT) Golf Outing.
- **19:** Missouri Truss Fabricators Association (MTFA) Golf Outing.

October

- **1-3:** 2008 Building Component Manufacturers Conference (BCMC), Colorado Convention Center, Denver, CO. Visit www.bcmcsow.com.
- **2:** Iowa Truss Manufacturers Association (ITMA) Chapter Meeting at BCMC.
- **2:** Mid South Component Manufacturers Association (MSCMA) Chapter Meeting at BCMC.
- **2:** WTCA Canada Chapter/Chapitre Canadien de la WTCA Meeting at BCMC.
- **7:** Tennessee Truss Manufacturers Association (TTMA) Chapter Meeting.
- **8:** Southwest Florida Truss Manufacturers Association (SWFTMA) Chapter Meeting.
- **9:** Wood Truss Council of Michigan (WTCM) Chapter Meeting.
- **15:** Georgia Component Manufacturers Association (GCMA) Chapter Meeting.
- **15:** WTCA-Arizona Chapter Meeting.
- **15:** WTCA-Northeast Chapter Meeting.
- **16:** Alabama Component Manufacturers Association (ACMA) Chapter Meeting.
- **16:** North Florida Component Manufacturers Association (NFCMA) Chapter Meeting.
- **16:** Southern Nevada Component Manufacturers Association (SNCMA) Chapter Meeting.
- **16:** WTCA-Indiana Chapter Meeting.
- **16:** WTCA-New York Chapter Meeting.
- **21:** California Engineered Structural Components Association (CalESCA) Chapter Meeting Online via **SBC Connection**.

November

- **5:** Wood Truss Council of the Capital Area (WTCCA) Chapter Meeting.
- **12:** Joint North Carolina and South Carolina Chapter Meeting.
- **13:** Mid Atlantic Wood Truss Council (MAWTC) Chapter Meeting.
- **13:** Wisconsin Truss Manufacturers Association (WTMA) Chapter Meeting. **SBC**

For more information about chapter meetings contact Anna (608/310-6719, astamm@qualtim.com) or Dani (608/310-6735, dbothun@qualtim.com).

Advertiser Index

Anthony Forest Products ☼	37
A-NU-PROSPECT ☼	38
Clark Industries, Inc. ☼	13, 60
Commercial Machinery Fabricators, Inc. ☼	22-23
Eagle Metal Products ☼	31
Eide Integrated Systems LLC ☼	53
Finnforest USA ☼	11
The Hain Company ☼	38
HOLTEC Corporation ☼	4
Hundegger USA L.C. ☼	9
ITW Building Components Group ☼ (Alpine, Truswal, IBS)	32-33, 63
Klaisler Manufacturing Corp. ☼	11
The Koskovich Company ☼	29, 61
Lakeside Trailer Manufacturing, Inc. ☼	40
Manitou North America, Inc. ☼	52
MITek Industries, Inc. ☼	2-3
Monet DeSaw Inc. ☼	64
MSR Lumber Producers Council ☼	20
NUCONSTEEL ☼	27, 54-55
Open Joist 2000 Inc. (Distribution) ☼	58
PANELS PLUS ☼	25
Pennsylvania Lumbermens Mutual Insurance Co. ☼	18
PFP Technologies ☼	39
Pratt Industries, Inc. ☼	20
Qualtim, Inc. ☼	58
Simpson Strong-Tie Company, Inc. ☼	21
SL-Laser Systems LP ☼	20
Southern Pine Council	17
Stiles/Homag Canada/Weinmann ☼	57
TCT Manufacturing, Inc. ☼	19
Triad/Merrick Machine Co. ☼	34
Trim Fit LLC ☼	35
Turb-O-Web USA, Inc. ☼	28
Viking Inc ☼	59
Wasserman & Associates, Inc. ☼	28
Wood Truss Systems, Inc. ☼	58
WTCA ☼	8, 15

☼ Gold ☼ Silver ☼ Bronze

For more information & to contact **SBC** advertisers, visit www.sbcmag.info/advertisers.

New Products

**Build your robotics future.
One piece at a time.**



Automated Saws



Material Handling Systems



PLANX™ Automated Jigging

- Immediate labor savings achieved with MISER coupled with Material Handling.
- Build trusses in 2 1/2 minutes using PLANX with Virtek laser imaging.

Integrated together — achieve robotic system output at 1/3 the investment.

COME SEE US AT BCMC '08 DENVER



www.KoskovichCompany.com or Call 507.286.9209



Classified Ads

STEEL TRUSS DESIGNER

Northern NE light gauge steel framing company seeking talented truss designer. Responsibilities to include roof truss, wall and floor panel layout and design. Keymark used but other software experience acceptable. SEI works with cold formed steel but wood experience acceptable. Resumes to hr@steelelements.com.

Summary of Proposed Eco-Forest Management Labeling of Softwood Lumber

WTCA component manufacturers attended a July forum in Kansas City to talk about an alternative to eco-certifiers' chain of custody requirements. They were joined by other purchasers and resellers of dimension lumber products like lumber mills, wholesalers, retailers, and manufacturers to discuss a LBM Institute (LBMI) program for labeling softwood lumber with two of the most recognized eco-certifiers—FSC and SFI.

In a written proposal distributed at the forum, the LBM Institute, WTCA members and the lumber group argued that eco-certifiers' current chain of custody requirements are "administratively complex and expensive to implement, and, conceivably, may soon actually threaten the competitive

sourcing of dimension lumber."

To address the expense and inefficiency of such requirements, the lumber industry group has petitioned the American Lumber Standards Committee (ALCS) to consider an eco-labeling program that would parallel PS-20 grade-stamping. It also provides permanent documentation of whether the product meets design specification and/or building code. LBMI's "eco-label" option would fit into the current PS-20 grade-stamping procedures. It would essentially attach the chain of custody to the product itself and the lumber could come from any of the major forest certification programs (FSC, SFI, PEFC, STFS and CSA).

On August 27, LBMI will present its proposal to the ALSC Administrative & Finance Subcommittee meeting, after which point ALSC will evaluate if the "eco-label" approach is compatible with its present operations and what the ultimate impact on industry is likely to be. If acceptable to its full committee, ALSC will consider adopting a policy or rule governing authorization of accreditation groups to implement eco-labeling of dimension lumber at production, and before entry to a commerce channel.

WTCA believes that the adoption of an "eco-label" would be highly beneficially to component manufacturers as a way of simplifying chain of custody procedures. **SBC**



Parting Shots

Share your stories and photos with us! Send submissions to partingshots@sbcmag.info.



WTCA member American Pole and Timber provided these larger-than-life components for a new Wal-Mart store in Waynesville, NC.

Eric Lincoln, the Senior Project Consultant for the job, worked with the architect's specifications to create the truss design. "This project was a big deal for Wal-Mart," said Lincoln. "They wanted to soften up the front of the store, and after going through many ideas and designs, they decided on the heavy timber trusses."

Lincoln said the massive 8x16 trusses measured 28' tall and 58' long, each weighing in at a hefty 11,000 lbs. Because of their size, Lincoln said getting the product to the jobsite took several steps. "The challenge was building



a truss that big in our facility, disassembling it completely [for shipment], and then reassembling it on the jobsite, without problems." After the trusses were built in the shop, they were pressure treated and then shipped to the jobsite in pieces, said Lincoln.

American Pole and Timber's work left a positive impression on Wal-Mart. "The man that put this together has been building new Wal-Mart stores for 28 years, but this was the first time he used heavy timber," said Lincoln. "He really loved working with the timber and said this store is his favorite." The project was such a success that American Pole and Timber has high hopes that Wal-Mart will consider using heavy timber again for future stores. **SBC**



ELMER, IT MAY HAVE TAKEN YOU 40 YEARS TO ACCUMULATE, BUT IT HARDLY QUALIFIES AS A 'TOURIST ATTRACTION!'



Great companies focus on growth. They see possibilities. They create success.

Great companies find business partners that understand their needs. Intelligent Building Systems offers structural framing software and equipment that intuitively produce wall panels. You can depend on IBS to increase your profitability by offering options that complement your existing product line.

Our most powerful machine to date -the Single Tool Bridge - includes vertical and horizontal fastening, automated wall depth adjustment, infinite "high-speed" fastener spacing and angled seam stitching that effectively eliminates blowouts!

Build Something Smart. Build Something Great.



Single-Tool Bridge

See our new automated fastening at BCMC 2008 Sheathing has never been easier!

Call us.

Together, let's build something smart. Let's build something great.



Intelligent Building Systems

866-204-8046

www.intelbuildsys.com

ITW Building Components Group Inc.

ASK YOURSELF ...

- ARE YOU TOLD "WE DON'T SUPPORT THAT MODEL & YEAR ANYMORE" ?
- INSTALLATION TAKES LONGER THAN 4 HOURS ?
- ARE YOU WAITING DAYS FOR SAW REPAIR ?
- ARE YOU SATISFIED WITH YOUR TECH SUPPORT ?



**Saw Parts For
Every Model From
1970 to Present**

**Professional Grade
Engineering Backed
By**

Knowledgeable Staff



**Professional Grade
Support**

**Computers & Tech
Support for Multiple
Saw Manufacturers**

**Minimum Down
Time - Same day
shipment on parts**

**Call Today
1-877-642-4900**



Quick Response



**Installation of all models
in less than 4 hours**



**3100 Dogwood Drive, Fulton
Missouri 65251
573/642-4900 - Fax 573/642-3736
email: sales@desauw.net
<http://www.desauw.net>**



Made in Mid-Missouri

MONET DESAUW, INC.