

**Winner of the 2020 DLA Defense
Manufacturing Technology Achievement Award!**



INTEGRATED CASTING ORDER NETWORK

Foundries and Machine Shops
Supporting America's Warfighters



***Driving Value to the Defense Logistics Agency by
Providing Innovative Procurement Solutions for
Defense and Military Related Metal Castings***

icon.nffs.org

Procurement Solutions and Tools for Metal Castings, Including Parts that Require Machining

Problem: Castings and assemblies containing metal castings are among the most difficult items for DLA to purchase. Defense contractors often experience significant problems in locating the required foundry tooling, identifying foundry suppliers capable of meeting material and process requirements, and connecting to machine shops with the right capabilities that can work with foundries to complete the procurement component. The result is a fragmented supply chain, leading to increased costs, long lead times and an overall reduction in supply chain capability.

Solution: ICON helps restore supply chain integrity for metal castings by providing visibility on the location of defense related foundry tooling, the specific material and process capabilities for hundreds of foundries across the country and by providing access to open bid solicitations available for DLA that contain one or more metal castings.

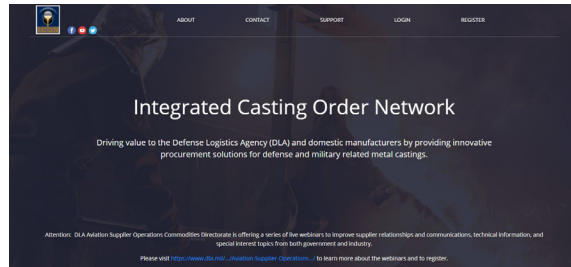

Many of DLA's back-orders and supply chain readiness issues occur due to the lack of visibility of previous supply chain for cast parts beyond the original equipment manufacturer (OEM)

Min Estimated Cost: 0																	
Open (795)	Closed (3348)	Awarded (20099)	Cancelled (7645)	Matched (795)	Flagged (38)	To Be Quoted (22)	In Process (1)	Archived (97)									
#	Folder	Date	Solicitation #	Close Date	Status	NSN	Last Award Date	My Part Num...	Tooling CAGE	Description	Qty	UI	Est. Value	SRVA	Type	AMC/AMSC	Materials / Methods
F2		2022-04-08	SPE7M42203027	2022-04-18	Open	4820010719871	2021-09-16		76364 / Public	BALL VALVE	65	EA	\$41,210.00	17	Casting	1G	Copper / Casting Copper / Centrifugal Casting
F2		2022-04-07	SPE7M42203027	2022-04-18	Open	4730014654444	2022-03-25			CLAMP COUPLING PIPE	146	EA	\$2,991.54	70	Suspect Casting	3L	Unspecified / Unspecified
F2		2022-04-07	SPE6A42203029	2022-04-15	Open	3120006186730	2020-04-27			BEARING SLEEVE	2	EA	\$193.00	0	Suspect Casting	1G	Unspecified / Unspecified
F2		2022-04-07	SPE6A42203082	2022-04-18	Open	1560011837256	2022-03-22		28993 / Private	STRUCTURAL SUPPORT	106	EA	\$275,600.00	54	Casting	1G	Aluminum / Unspecified
F2		2022-04-07	SPE7M42203084	2022-04-18	Open	4820011321754	1901-01-01		43689 / Public	DISK VALVE	30	EA	\$2,939.76	30	Casting	1G	Nickel / Casting
F2		2022-04-07	SPE7M42203084	2022-04-18	Open	4820011734694	2021-10-27			DIRECT LINEAR VALVE	27	EA	\$8,720.73	18	Casting	3B	Aluminum / Casting
F2		2022-04-07	SPE7L52203485	2022-04-18	Open	1005003295953	2022-03-16		58235 / Public	CATCH CHARGER SLIDE	19	EA	\$2,755.00	15	Casting	1G	Steel / Investment Casting

Industry user "inbox" of government business opportunities

Daily Sales Opportunities

ICON provides daily email notifications for open solicitations that meet your material and process capabilities, or your existing tooling, based on your own customizable "bid match" settings for your foundry.



Dear ICON user,

You have the following new solicitations for review on the [NFFS ICON Portal](#):

- Number of new confirmed casting solicitations: 4
- Number of confirmed casting solicitations matching your ICON product records: 0
- Number of confirmed casting solicitations matching your organization's bid match settings: 4
- Number of new suspect casting solicitations: 11

Bid Match Settings

Materials: aluminum, cobalt, copper, iron, lead, magnesium, nickel, steel, titanium, unspecified
 Methods: casting, centrifugal casting, die casting, investment casting, permanent mold casting, plaster casting, sand casting, unspecified
 Minimum Quantity: 1
 Minimum Estimated Cost: \$0

The total estimated value of today's solicitations is \$5,117,341.49.

Questions or comments pertaining to solicitations should be directed to the buyer listed on the solicitation document.

If you have questions or need assistance pertaining to the ICON portal, please direct your inquiries to: support@nffs.org

Tooling and Supplier Capabilities

ICON is the nation's authoritative source for defense and military foundry tooling records, providing visibility on more than 34,000 tooling records. Quickly identify if foundry tooling exists for specific National Industry Identification Numbers (NIIN), and where it is located. If no tooling exists, use our comprehensive supplier capability database to identify a foundry or machine shop capable of manufacturing your item based upon material and process requirements.

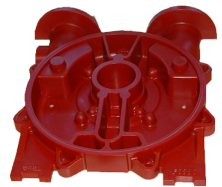

353 supplier(s) found										
Company	CAGE	Address	City	State	Zip	Point of Contact	Email	Phone		
21ST CENTURY DIE ...	49262	1001 W RIGGIN RD	Muncie	IN	47303-6419	GREGG PHILLIPS	contact@phillipsatt...	765-289-2816		
A & B FOUNDRY INC	1A004	835 North Main Str...	Franklin	OH	45005	Vik Sahni	Vik@andbfoundry...	937-746-3634		
A C FOUNDRY INC	9X262	1146 N Raymond Rd	Battle Creek	MI	49014-5817	Tim Cherrington	tcherrington@metl...	269-963-8539		
A W BELL PTY LTD	27810	145 Abbotts RIDG...	DANDENONG SOUTH	AL	3175	Sam Ball	samb@awbell.com.au	61 3 9799 9555		
A.C.E. TOOLING, INC.	81P14	1188 E Broadway Ave	Norton Shores	MI	49444	JOHN PATTERSON	JOHN@ACETOOLING...	2317400187		
A.M.E METALS, INC	1YMR8	103 KESWICK CT	AMHERST	OH	44001-2368	ERIN INFANTE	eriv@amemetals.com	440-985-3749		
ABECO DIECASTING...	0GLE5	1424 Higgs Road P.O...	Lewisburg	TN	37091	Mitch Newman	mitch@abecodiecas...	931-359-4287		
ABERLE INDUSTRIAL...	SC8N0	4860 Van Gordon St...	Wheat Ridge	CO	80033	Steven Aberle	aberleinf@yahoo.c...	303-423-1001		
ACME FOUNDRY, INC.	95923	1502 Spruce Street	Coffeyville	KS	67337	Scott Talman	staltman@acmefoun...	620-251-6800		
ACRA CAST INC	1A288	1837 FIRST ST	Bay City	MI	48708	R. Singer	sales@acracast.com	989-893-3961		
ADAMS & WESTLAK...	70109	940 N MICHIGAN ST.	ELKHART	IN	46514-2216	Mike Rozesko	miker@adslake.com	574-264-1141		

Is Your Company Listed?

WHO USES ICON?

- Acquisition and Purchasing Professionals, Foundries & Machine Shops
 - » Identify foundries and machine shops of the casting supply chain, including supplier contact information and historical pricing
 - » Locate sources of supply and tooling
 - » Pinpoint sources of purchased casting components by government agencies with an extensive award history
- Integrated Logistics Support Teams, Industry and Government Engineers
 - » Ensure compliance with specifications and standards
 - » Identify sources for potentially fragmented or diminished casting sources of supply, including supplier contact information
 - » Quickly identify and retrieve existing parts information to streamline internal processes.

Providing Castings to the Warfighter

Contract Management starts with the ability to submit quotations via ICON's unique **Quotation Management System (QMS)** directly to the DLA Internet Bid Board (DIBBS). The interactive contract features save time and eliminate mistakes. Users can create purchase orders (POs) with the push of a button and/or recall vendor pricing from the database.

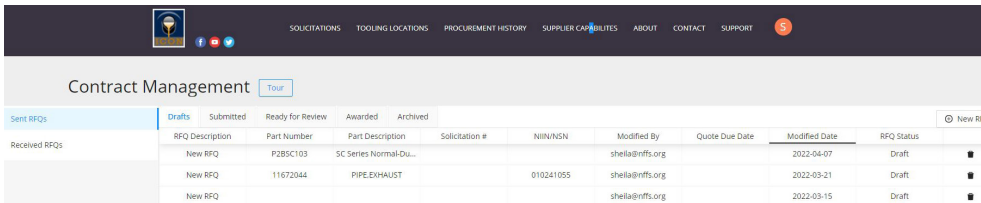

Manage and search procurement history on the entire PO in a **single database**, including researching, reprinting and/or re-issuing old purchase orders. Create, Receive and Reject orders directly in ICON using QMS.

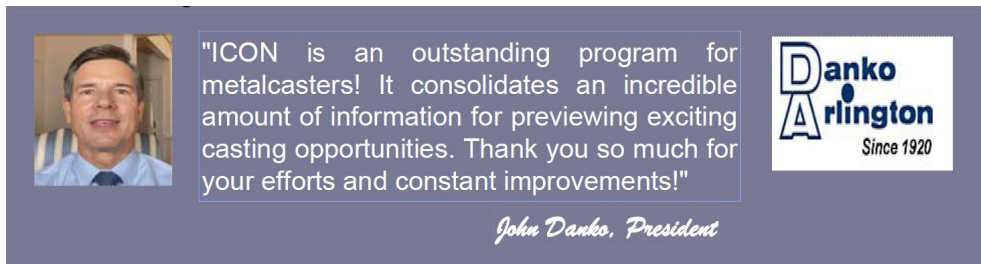

ICON adheres to the most effective and secure access to defense logistics agency (DLA) and department of defense military casting opportunities; tooling searches and a robust suppliers capabilities database of government and commercial suppliers. Multiple search criteria is available to locate tooling.

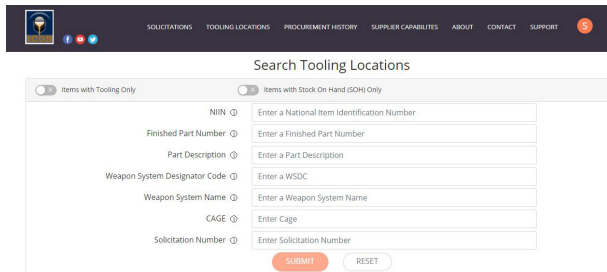

ICON... Complete Procurement Solution for Casting and Machining

Bid Matching

Take the guess work out of searching and filtering for solicitations with ICON's robust **"Bid Matching"** process. ICON does the filtering for you!

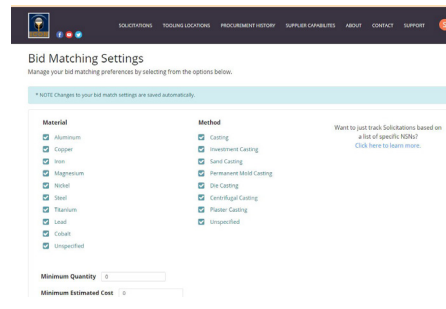

ICON Procurement History

Searches by National and Stock Number (NSN), Commercial and Government Entity (CAGE) code, and drill down to more specific details of each item inside ICON. Build competitive proposals around **past procurement price history** and win that award!

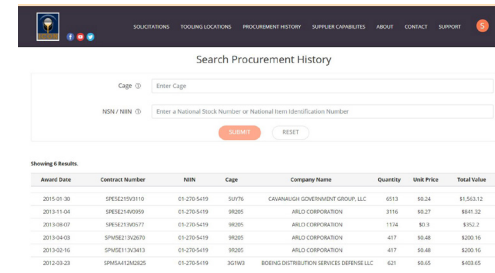

Inventory Management

ICON allows industry users to manage their available inventory, and allows industry and government buyers to locate and purchase those items directly from the supplier entirely within the ICON portal.

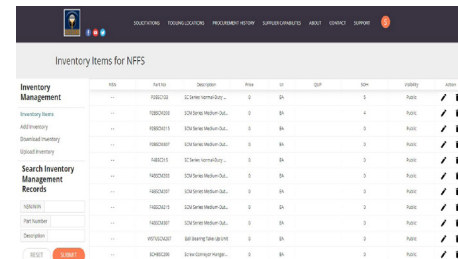

ICON Messaging

Messaging in ICON is a "business to business" connection. Communicate directly with other suppliers, upload documentation and complete a quoting process on orders as part of the prime business opportunity.

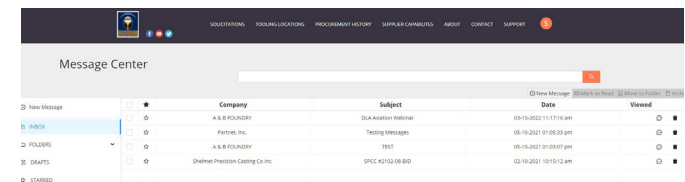

Managing and Directing

A Procurement Solution of DoD and DLA Business Opportunities

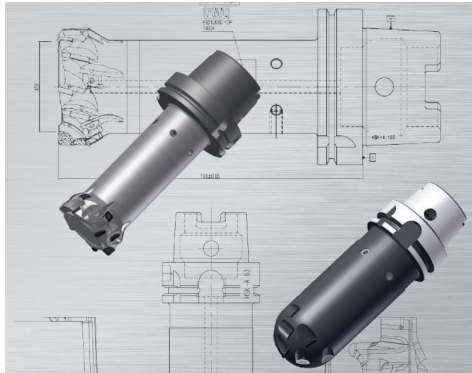

ICON provides the ability for industry to become certified in their supplier capabilities on procurements and for future demands.



ICON provides access to online training and user training materials with a focus on the casting industry.

Partnership with Suppliers



- Quickly find suppliers, available parts and alternative resources
- Design more efficiently while complying with specs and standards
- Ensure materials are delivered at the right place, time and cost from qualified suppliers
- Manage obsolescence and ensure continued casting parts supply
- Develop and grow your business by monitoring government solicitations

Getting Started

Where can I go for information about...?

- **Obtaining a valid CAGE (Commercial and Government Entity) code?**

Note: You do not need a CAGE code to register in ICON. It is required to be a prime on a government contract.

Register at: <https://www.sam.gov>

- **Obtaining and downloading Technical Data Packages?**

Register at the DLA's Product Data Management Initiative (PDMI) website, cFolders, at: <https://pcf1x.bsm.dla.mil/cfolders/>

- **Submitting proposals for casting solicitations?**

Register at the DLA Internet Bid Board (DIBBS) website: <https://www.dibbs.bsm.dla.gov/>

- **Signing up for the ICON program?**

Register for ICON at: <https://icon.nffs.org>

ICON Historical Facts

- Since October 2017, ICON has directed more than 27,000 sales opportunities to foundries and machine shops worth more than \$1 billion.
- ICON users have received more than 12,000 contracts valued at over \$319 million in sales volume.
- The ICON program has made major contributions to reducing administrative and production lead times for DoD cast metal components, reducing part and tooling costs, and reestablishing domestic supply chain capabilities for these items.

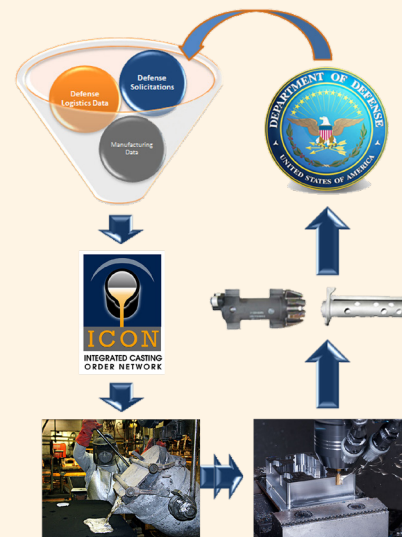

In 2020, the ICON program was chosen by the Defense Logistics Agency (DLA) to receive the prestigious Defense Manufacturing Technology Achievement Award (DMTAA). The competitive award is to recognize individuals in private sector or government with achievements that further the vision of the Department of Defense (DoD) Manufacturing Technology (ManTech) Program.

Sponsors and Contact Information

The Integrated Casting Order Network (ICON)
is sponsored by:

Defense Logistics Agency – Troop Support
(Philadelphia, PA)

Defense Logistics Agency – Information Operations,
J68, Research & Development
(Ft. Belvoir, VA)

For more information about ICON, contact:



Sheila Rayburn
ICON Sr. Program Manager
Non-Ferrous Founders' Society

Phone: 847.268.4876

Email: sheila@nffs.org

Web: <https://icon.nffs.org>

OUR PARTNERS

