

***2019 SPECTRUM
EDUCATIONAL
CONFERENCE &
TRADE SHOW
September 19, 2019
Oregon Convention Center***

EXHIBITOR KIT

Please retain copies of the completed order forms for your records.
Make sure to mail, fax or email completed copies with payment to each
contractor providing services.





2019 SPECTRUM EDUCATIONAL CONFERENCE

Oregon Convention Center

September 19, 2019

S09199

Advance Price Deadline: September 4, 2019

SHOW INFORMATION

Welcome to the 2019 Spectrum Educational Conference & Trade Show. DWA is pleased to have been selected as your official convention services contractor. In addition to furniture, carpet, and custom displays, we offer full-service graphics, labor, and freight handling services. Our goal is to help make your show participation a success.

Please contact the DWA Customer Service Department with any questions. We will do our best to assist you with all your show needs and appreciate the opportunity to work with you.

TO VIEW OUR RENTAL ITEMS, PLEASE VISIT OUR WEBSITE AT WWW.DWATRADESHOW.COM

HOW TO CONTACT US: DWA Trade Show & Exposition Services
6700 NE 59th Place
Portland, Oregon 97218
Phone: 503/228-6800
Fax: 503/595-1470
e-mail: csr@dwatradeshow.com

BOOTH INFORMATION: Backwall Drapes: Silver
Siderail Drapes: Silver
Booth Size: 10' x 10'
Aisle Carpet: Silver
PLEASE NOTE: THE BOOTHS ARE NOT CARPETED.

BOOTH PACKAGE: Show Management is providing each exhibitor with the following:
One 7" x 44" Booth Identification Sign, One 6' Table Skirted Silver and Two Chairs

ADVANCE PRICE DEADLINE: The last day to receive DWA advance pricing is: September 4, 2019

FOR YOUR CONVENIENCE WE OFFER AN ONLINE ORDERING SYSTEM!

Please follow the steps below to order your services online:

- 1. Go to DWA Trade Show & Exposition Service's website at http://www.dwatradeshow.com
2. Select "Online Ordering" from the Home Page
3. Set up an account (if you have an account already select that option)
4. Enter the show code 2019Spectrum
5. You will be taken to the Show Information page where you will need to enter your booth number and company name
6. Begin entering your order

Important: We have included links and information for other contractors' products and/or services. We claim no responsibility for their products or services. Please contact them directly for questions.

FREIGHT HANDLING: DWA can receive your show freight and deliver it to your booth space. Please read the Freight Handling forms for further information and for Freight Handling rates. Be sure to complete and return the Freight Handling order form to DWA before shipping.

Advance Shipping Address: SPECTRUM
COMPANY NAME - BOOTH #
c/o DWA
6700 NE 59th Place
Portland, Oregon 97218

To avoid additional after deadline charges, shipments must arrive by: September 13, 2019

Direct Shipping Address: SPECTRUM
COMPANY NAME - BOOTH #
c/o DWA
Oregon Convention Center, Hall D
777 NE MLK Jr. Blvd.
Portland, OR 97232

All direct shipments must be consigned to DWA and scheduled to arrive during official exhibitor move-in hours only. First day to receive freight at the exhibit site: September 18, 2019



2019 SPECTRUM EDUCATIONAL CONFERENCE
 Oregon Convention Center
 September 19, 2019
 S09199
 Advance Price Deadline: September 4, 2019

PAYMENT POLICIES & CREDIT CARD CHARGE AUTHORIZATION
 KEEP ORIGINAL & SEND COPY TO DWA

Please complete the information requested and return payment in full with this form and your orders.

VISA MASTERCARD AMERICAN EXPRESS DISCOVER Personal Corporate

Account Number																					
Expiration Date			/			Three or Four Digit Security Code															
Cardholder's Name										Please Print											
Cardholder's Billing Address										City											
State					Zip					Country											
Cardholder's Signature																					

ADVANCE PRICING

To qualify for advance pricing, orders must be received on or before the advance price deadline with payment in full. Late orders and orders without payment will be charged at standard prices.

PAYMENT FOR SERVICES

DWA requires payment in full at the time services are ordered. If paying by credit card, for your convenience, we will use this authorization to charge your account for services, which may include labor and freight handling not covered by your initial order and orders placed at exhibit site by your company representative.

METHOD OF PAYMENT

DWA accepts MasterCard, Visa, Discover, American Express, cash and check. Purchase orders are not considered payment. All payments must be made in U.S. funds drawn on a U.S. bank. Your cancelled check/bank statement and copies of the order form(s) are your receipts. Exhibitors will be charged a \$25.00 fee for returned NSF checks.

TAX EXEMPT

If you are tax exempt in the state in which you will be exhibiting, you must provide a Sales Tax Exemption Certificate for that state. Please send the above information to the DWA office for this show. DWA must receive your certificate by the deadline date on the order forms; otherwise tax will appear on your invoice.

ADJUSTMENTS, CANCELLATIONS AND REFUNDS

Adjustments to your invoice will not be made after the close of the show. Some items, services and labor are subject to cancellation fees. Refer to each order form for details.

CALCULATION OF ORDERS

Furniture, Accessories, Carpet.....	\$		TOTAL FROM EACH ORDER FORM
Signs.....	\$		
Labor/Forklift.....	\$		
Material Handling.....	\$		
Other DWA Services (please specify) _____	\$		
Other DWA Services (please specify) _____	\$		
Other DWA Services (please specify) _____	\$		
TAX ID #93-0642167			
	TOTAL ORDER	\$	
	Charge my credit card in the amount of	\$	
	I have enclosed check number _____ dated _____ in the amount of	\$	

Company Name		Booth Number	
Billing Address		City	State Zip Code
Telephone		Fax	E-mail
Authorized Contact Signature		Authorized Contact-Please Print	Date

All orders are governed by DWA's Payment Policy and Limits of Liability and Responsibility.

All orders are governed by the DWA Payment Policy and Limits of Liability & Responsibility.

Please read carefully.

1. DWA and its subcontractors shall not be responsible for ordinary wear and tear in handling of equipment, damage to uncrated materials, materials packed improperly, glass breakage or concealed damage. Claims for loss or damage must be submitted to DWA by the close of the show. No suit or action shall be brought against DWA or its subcontractors more than six months after the cause of action accrues.
2. DWA and its subcontractors are not responsible for the loss of, disappearance of, or damage to Exhibitor's freight after the same has been delivered to Exhibitor's booth, nor are DWA and its subcontractors responsible for Exhibitor's freight before it is picked up from Exhibitor's booth for loading after the show. Exhibitors must submit a DWA bill of lading for all outbound shipments. All bills of lading covering outgoing shipments submitted to DWA or its subcontractors by Exhibitor will be checked at the time of pickup from the booth and corrected where discrepancies exist.
3. It is agreed that DWA and its subcontractors are not insurers. Insurance, if any, shall be obtained by Exhibitor. Amounts payable by DWA hereunder are based on the scope of liability as herein set forth and are unrelated to the value of the Exhibitor's property. It is further agreed that DWA and its subcontractors do not provide for full liability should loss or damage occur. In the event that DWA should be found liable for loss or damage to Exhibitor's equipment, the liability shall be limited to the specific article that was physically lost or damaged. Such liability shall be limited to a sum equal to \$.30 per pound/per article with a maximum liability of \$50.00 per item or \$1,000 per shipment, whichever is less, as agreed upon damages and exclusive remedy. Provisions of this paragraph shall apply if loss or damage, regardless of cause of origin, results directly or indirectly to property through performance or nonperformance of obligations imposed by the offering of services to Exhibitors, or from negligence, active or otherwise, by DWA, its subcontractors or their employees.
4. At the close of show, if carriers fail to pick up or refuse to accept shipment, DWA reserves the right to reroute such shipment or move shipment to our warehouse pending advice from Exhibitor who will be charged accordingly for this service. No liability will be assumed as a result of such rerouting or handling. Thus, in order to expedite removal of materials from the show site, DWA shall have the authority to change designated carriers, if such carriers do not pick up on time. Where no disposition is made by Exhibitor, materials will be taken to DWA's warehouse to await Exhibitor's shipping instructions, and Exhibitor agrees to be responsible for payment of charges relating to such handling at the warehouse. DWA assumes no liability as a result of such rerouting or handling.
5. DWA and its subcontractors shall not be liable for shipments received without receipts, freight bills or bill of lading, such as UPS or van lines, these shipments will be delivered to booth without guarantee of piece count or condition. No liability will be assumed for such shipments. Shipments received on separate days will be treated as separate minimum shipments.
6. DWA and its subcontractors shall not be liable to any extent whatsoever for any actual, potential or assumed loss of profits or revenues or for any collateral costs that may result from any loss, injury or damage to Exhibitor's materials or Exhibitor personnel which may make it impossible or impractical to exhibit same.
7. The Exhibitor agrees, in the event of a dispute with DWA or its subcontractors relative to any loss or damage to any of the Exhibitor's freight or equipment, that the Exhibitor will not withhold payment in any amount due to DWA for freight handling services or any other services provided by DWA or its subcontractors as an offset against the amount of the alleged loss or damage. Instead, the Exhibitor agrees to pay DWA prior to the close of the show for all such charges and further agrees that any claim the Exhibitor may have against DWA or its subcontractors shall be pursued independently by the Exhibitor as a completely separate transaction to be resolved on its own merits.
8. DWA and its subcontractors shall not be responsible for any loss, delay, or damage due to events beyond their reasonable control which cannot be avoided by the exercise of due care and prudence, including without limitation, strikes, labor disputes, lockouts or work stoppages of any kind, fire, theft, windstorm, water, vandalism, acts of God, mysterious failure of power or utilities, and other events.
9. The Exhibitor agrees, in connection with the receipt, handling, temporary storage and reloading of its freight, that DWA and its subcontractors will provide these services as Exhibitor's agent and not as bailee or shipper. If any employee of DWA or its subcontractors shall sign a delivery receipt, bill of lading or other document, the parties agree that DWA or its subcontractor will do so as the Exhibitor's agent, and the Exhibitor accepts the responsibility thereof.
10. Empty Storage labels will be available at the DWA Service Desk. Affixing the labels is the sole responsibility of the Exhibitor or its representative. It is understood that these labels are used for empty storage only, and DWA and its subcontractors assume no responsibility or liability for loss or damage to contents while containers are in storage or for mislabeled containers.
11. Rates are subject to Union contract changes and rates effective at time of show. Rates include Social Security, Worker's Compensation Insurance and Public Liability Insurance. DWA and its subcontractors shall not be responsible for loss, delay or damage due to strikes, lockouts, or work stoppages of any kind.
12. Please ship early and ship prepaid. DWA will not accept collect shipments.



FURNITURE & ACCESSORIES ORDER FORM

KEEP ORIGINAL & SEND COPY TO DWA

TO VIEW RENTAL ITEMS, PLEASE SEE OUR WEBSITE!

CHAIRS				
Quantity	Description	Advance	Standard	Total
110	Plastic Side Chair	\$20.00	\$30.00	
120	Fabric Side Chair	\$36.00	\$46.00	
130	Fabric Arm Chair	\$40.00	\$52.00	
140	Barstool	\$45.00	\$55.00	
126	Steno Chair without Arms	\$65.00	\$75.00	

ACCESSORIES				
Quantity	Description	Advance	Standard	Total
220	Wastebasket	\$ 9.00	\$11.00	
230	Aluminum Easel	\$22.00	\$29.00	
240	Chrome Stanchion	\$25.00	\$31.00	
241	Velour Rope/6'	\$18.00	\$25.00	
254	Magazine Rack/6 slot	\$54.00	\$67.00	
257	Waterfall Bag Rack	\$51.00	\$66.00	
258	Chrome Signholder	\$51.00	\$66.00	
260	Coat Tree	\$36.00	\$46.00	
14	8' Upright with Base	\$12.00	\$15.00	
15	6' - 10' Extension Bar	\$12.00	\$15.00	
92	Executive Desk	\$195.00	N/A	
90	Showcase-6' w/2 Shelves	\$298.00	N/A	

TABLE TOP RISERS - 8" Deep (Includes white vinyl covering)				
Quantity	Description	Advance	Standard	Total
271	4' Single Tier, 8" or 15"	\$35.00	\$45.00	
273	6' Single Tier, 8" or 15"	\$42.00	\$53.00	
272	4' Double Tier, 8" and 15"	\$68.00	\$85.00	
274	6' Double Tier, 8" and 15"	\$74.00	\$92.00	

CUSTOM DRAPE - 4' Minimum Order (includes frame)				
Quantity	Description	Advance	Standard	Total
1100	3' High Drape/Per LF	\$ 8.00	\$10.00	
1105	8' High Drape/Per LF	\$10.00	\$12.00	

Available Drape Colors: 1 Blue 2 Red 3 Green 4 Silver
 5 Burgundy 6 White 7 Black 8 Teal 9 Plum 11 Beige

PERFBOARD/TACKBOARD - 4' x 8' Panels (Perfboard rental does not include hardware)				
Quantity	Description	Advance	Standard	Total
280	Perfboard	\$90.00	\$112.00	
281	Tackboard Grey Fabric	\$90.00	\$112.00	

Vertical Horizontal (Please check your choice of installation)

TABLES				
Quantity	Description	Advance	Standard	Total
210	Coffee Table/18x36x17H	\$40.00	\$50.00	
211	Side Table/17x17x17H	\$35.00	\$44.00	
200	Cocktail Round/30Hx36D	\$62.00	\$77.00	
205	Cocktail Pedestal/42Hx36D	\$67.00	\$83.00	
500	5' Round Undraped/30H	\$32.00	\$39.00	
501	5' Round w/Linen/30H	\$56.00	\$65.00	
1000	54" Linen / Square	\$20.00	\$26.00	
1001	90" Linen / Round	\$23.00	\$29.00	

Select Linen Color: Blue White Black Plum

DISPLAY TABLES - 30" High x 24" Wide
(Check color below / 6' & 8' tables skirted 3 sides only)

Qty.	Description	Advance	Standard	Total
424S	4' Skirted Table	\$65.00	\$82.00	
624S	6' Skirted Table	\$75.00	\$92.00	
824S	8' Skirted Table	\$82.00	\$99.00	
424U	4' Unskirted Table	\$40.00	\$50.00	
624U	6' Unskirted Table	\$45.00	\$56.00	
824U	8' Unskirted Table	\$50.00	\$62.00	
1010	4th Side Skirt-30"	\$30.00	\$45.00	

DISPLAY COUNTERS - 42" High x 24" Wide
(Check color below / 6' & 8' counters skirted 3 sides only)

424SC	4' Skirted Counter	\$73.00	\$91.00	
624SC	6' Skirted Counter	\$81.00	\$101.00	
824SC	8' Skirted Counter	\$90.00	\$112.00	
424UC	4' Unskirted Counter	\$50.00	\$62.00	
624UC	6' Unskirted Counter	\$55.00	\$68.00	
824UC	8' Unskirted Counter	\$60.00	\$75.00	
1011	4th Side Skirt-42"	\$35.00	\$50.00	

SERPENTINE TABLES - 30" Wide
(Check color below / serpentine tables skirted 3 sides only)

430SS	Small Skirted Serpentine	\$ 94.00	\$117.00	
530SS	Large Skirted Serpentine	\$108.00	\$135.00	
430US	Small Unskirted Serpentine	\$ 49.00	\$ 61.00	
530US	Large Unskirted Serpentine	\$ 59.00	\$ 73.00	
1010	4th Side Skirt-30"	\$ 30.00	\$ 45.00	

Select Skirt Color: 1 Blue 2 Red 3 Green 4 Silver
 5 Burgundy 6 White 7 Black 8 Teal 9 Plum 10 Gold

Prices include installation, rental and removal. Include Sales and/or Use Taxes as indicated. Make payment in U.S funds drawn on a U.S. bank. **Cancellation Policy:** Items cancelled will be charged at 25% of original price prior to move-in, 50% after move-in begins and 100% after installation. **IMPORTANT NOTE:** Please do not hang any items from our drape backwall. DWA will not be responsible for any damage which may occur to exhibitor equipment that is placed on our drape backwall.

Company Name		Booth Number		All orders are governed by DWA's Payment Policy and Limits of Liability and Responsibility.
Billing Address		City	State Zip Code	
Telephone	Fax	E-mail		
Authorized Contact Signature		Authorized Contact-Please Print Date		

RETURN TO: DWA Trade Show & Exposition Services
 6700 NE 59th Place Portland, Oregon 97218
 Telephone: 503/228-6800 Fax: 503/595-1470
 E-mail: csr@dwa tradeshow.com
 http://www.dwa tradeshow.com

Total Rentals Ordered	\$	
Add 00% Sales and/or Use Tax	\$	-0-
PAYMENT ENCLOSED		\$



2019 SPECTRUM EDUCATIONAL CONFERENCE
 Oregon Convention Center
 September 19, 2019
 S09199
 Advance Price Deadline: September 4, 2019

CARPET, PADDING & VISQUEEN ORDER FORM
 KEEP ORIGINAL & SEND COPY TO DWA

STANDARD BOOTH CARPET
 Rental includes installation, front-edge taping and pick up at the close of the show.

Quantity	Size	Advance	Standard	Total
	₉₁₀ 9' X 10' 16 oz. Booth Carpet	\$ 95.00	\$118.00	
	₉₂₀ 9' x 20' 16 oz. Booth Carpet	\$190.00	\$237.00	
	₉₃₀ 9' x 30' 16 oz. Booth Carpet	\$285.00	\$356.00	
	₉₄₀ 9' x 40' 16 oz. Booth Carpet	\$380.00	\$475.00	

Select Carpet Color:

₁Blue ₂Red ₃Green
 ₄Gray ₇Black ₈Teal
 ₉Plum

STANDARD CUSTOM CUT BOOTH CARPET
 Includes visqueen plastic covering. All custom orders must be received 14 days prior to move-in to guarantee color selection.

Quantity	Size	Advance	Standard	Total
	₉₇₅ 16 oz. Custom Carpet/sq. ft.	\$ 1.60'	\$ 2.00'	

Select Carpet Color:

₁Blue ₂Red ₃Green
 ₄Gray ₇Black ₈Teal
 ₉Plum

Price for carpet includes delivery, rental, and removal. Labor to install carpet is included when the carpet is installed on a flat floor space prior to exhibit installation. Labor will be charged at published rates when installation is required for stairs, platforms, risers, meeting rooms, or other installations post exhibit installation.

CARPET PADDING

Quantity	Size	Advance	Standard	Total
	₉₇₃ Foam Padding/sq. ft.	\$ 0.60'	\$ 0.75'	

Cancellation Policy:
 Custom size booth carpet cancelled after being cut will be charged 100%. All other carpet cancelled will be charged 50% of original price after move-in begins and 100% of original price after installation.

VISQUEEN PLASTIC COVERING FOR PROTECTION
 Rental includes one-time installation and removal.

Quantity	Size	Advance	Standard	Total
	₉₇₂ Plastic Covering/sq. ft.	\$ 0.40'	\$ 0.50'	

Please include a layout diagram in the box below for installation of your carpet if your carpet size is different from your booth size to avoid any unnecessary delays or costs.

Prices include installation, rental and removal. Include Sales and/or Use Taxes as indicated. Make payment in U.S funds drawn on a U.S. bank. **Cancellation Policy:** Items cancelled will be charged at 25% of original price prior to move-in, 50% after move-in begins and 100% after installation. **IMPORTANT NOTE:** Please do not hang any items from our drape backwall. DWA will not be responsible for any damage which may occur to exhibitor equipment that is placed on our drape backwall.

Company Name		Booth Number		All orders are governed by DWA's Payment Policy and Limits of Liability and Responsibility.
Billing Address		City	State Zip Code	
Telephone		Fax	E-mail	
Authorized Contact Signature		Authorized Contact-Please Print	Date	

RETURN TO: DWA Trade Show & Exposition Services
 6700 NE 59th Place Portland, Oregon 97218
 Telephone: 503/228-6800 Fax: 503/595-1470
 E-mail: csr@dwa tradeshow.com
 http://www.dwa tradeshow.com

0214R

Total of Items Ordered	\$	
Add 00% Sales and/or Use Tax	\$	-0-
PAYMENT ENCLOSED	\$	

GRID PANEL & MINI GRID RENTAL ORDER FORM

KEEP ORIGINAL & SEND COPY TO DWA

(AVAILABILITY GUARANTEED ONLY IF ORDERED IN ADVANCE.)

Quantity	Description	Advance	Standard	Total
9800	GRID PANEL, 2' X 8', Black / Per Panel Each panel is 2' x 8' with a 3" x 3" grid. At least two panels are needed to be free standing. Feet must be rented to have a 2' x 8' free standing unit.	\$37.00	\$50.00	
9801	GRID PANEL FEET / Per Set of Two Feet are needed if you want to make one panel free standing.	\$27.00	\$35.00	
9802	MINI GRIDS / 14" x 14" / Per Grid Mini-Grid cube panels snap together with connectors into economical display cubes.	\$ 5.00	\$ 9.00	
9803	MINI GRID CONNECTORS / Bag of 12	\$ 3.00	\$ 5.00	

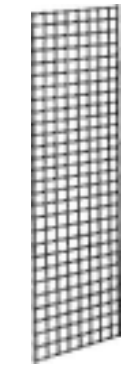

Grid Panel



Grid Panel w/Feet
(hardware not included)

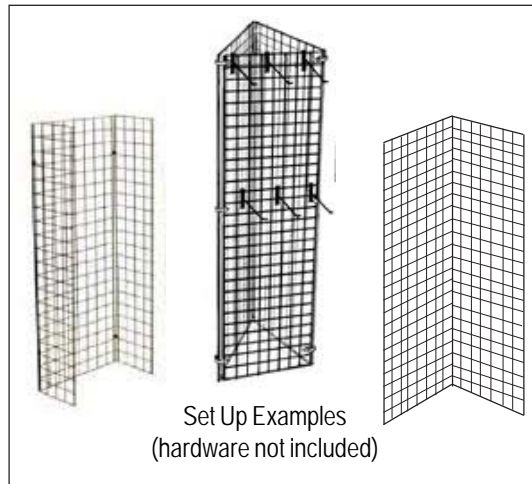

Set Up Examples
(hardware not included)

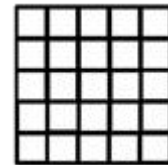

Mini Grid



Cubes made from Mini Grids
(Set Up Example)

Grid Panels will be delivered to your booth. You are responsible for set up. Zip ties will be available at the DWA Customer Service Desk. Labor may be ordered for assistance in assembling free standing units. Hardware for Grid Panels is not included. Please see Labor Order Form. GRID PANELS MAY NOT BE HUNG FROM BOOTH BACKWALL FRAME OR DRAPES.

Mini Grids must be picked up at the DWA Customer Service Desk.

Prices include delivery, rental and removal. Include Sales and/or Use Taxes as indicated. Make payment in U.S funds drawn on a U.S. bank. **Cancellation Policy:** Items cancelled will be charged 25% of original price prior to move-in, 50% after move-in and 100% after installation.

Company Name		Booth Number		All orders are governed by DWA's Payment Policy and Limits of Liability and Responsibility.
Billing Address		City	State Zip Code	
Telephone	Fax	E-mail		
Authorized Contact Signature	Authorized Contact-Please Print	Date		

RETURN TO: DWA Trade Show & Exposition Services
 6700 NE 59th Place Portland, Oregon 97218
 Telephone: 503/228-6800 Fax: 503/595-1470
 E-mail: csr@dwa tradeshow.com
 http://www.dwa tradeshow.com

0805C

Total Rentals Ordered	\$	
Add 00% Sales and/or Use Tax	\$	-0-
PAYMENT ENCLOSED	\$	

LOUNGE / RECEPTION FURNISHINGS

Quantity	Description	Advance	Standard	Total
	9211 Black Bonded Leather Loveseat (60" long x 36" wide x 33" high)	\$350.00	Not Available	
	9212 Black Bonded Leather Sofa (82" long x 36" deep x 33" high)	\$395.00		
	9213 Black Bonded Leather Chair (40" long x 36" deep x 33" high)	\$295.00		
	9214 Black Coffee Table (46.5" long x 29.5" wide x 18" high)	\$139.00		
	9219 Black End Table (21.58" x 21.58" x 19.58" high)	\$119.00		
	9215 Black Guest Chair	\$ 75.00		
	9216 Nils Chair-Charcoal or White Fabric / Circle Color Choice	\$ 85.00		
	9217 Wire & Wood Shelf Unit (66.5" long x 12" deep x 62" high)	\$ 95.00		
	9220 White Blixt Bar Stool	\$ 75.00		
	9225 Glass Showcase/Locking (64-1/8" tall x 14-3/8" deep x 16-3/4" wide)	\$ 175.00		



Black Loveseat



Black Sofa



Black Chair



Black Coffee Table



Black End Table



White Blixt Bar Stool



Wire & Wood Shelf



Nils Chair



Black Guest Chair



Glass Showcase/Locking

Prices include installation, rental and removal. Include Sales and/or Use Taxes as indicated. Make payment in U.S funds drawn on a U.S. bank. **Cancellation Policy:** Items cancelled will be charged at 25% of original price prior to move-in, 50% after move-in begins and 100% after installation.

Company Name		Booth Number		All orders are governed by DWA's Payment Policy and Limits of Liability and Responsibility.
Billing Address		City	State Zip Code	
Telephone		Fax	E-mail	
Authorized Contact Signature		Authorized Contact-Please Print	Date	

RETURN TO: DWA Trade Show & Exposition Services
 6700 NE 59th Place, Portland, OR 97218
 Telephone: 503/228-6800 Fax: 503/595-1470
 E-mail: csr@dwa tradeshow.com
 http://www.dwa tradeshow.com

011109R

Total of Items Ordered	\$	
Add 00% Sales and/or Use Tax	\$	-0-
PAYMENT ENCLOSED		\$

SILK PLANTS & FLORAL ARRANGEMENTS

Quantity	Description	Advance	Standard	Total
	9500 3' to 4' Tall Plant (Spath, Dieffenbachia/Ivy, Dracaena) circle selection	\$57.00	\$71.00	
	9501 5' to 6' Tall Plant (Areca Palm, Ficus) circle selection	\$68.00	\$85.00	
	9502 30" Hydrangea (Blue)	\$37.00	\$47.00	
	9505 15" Geraniums (Pink or Red)	\$23.00	\$31.00	
	9507 6" (1-1/2' wide) Fern	\$16.00	\$25.00	
	9508 8" (2-1/2' wide) Fern	\$25.00	\$35.00	
	9509 Floral Arrangement (call for quotes)	Upon Request	Not Available	



Please Note: Photos are not to scale.

Rental items are the responsibility of the exhibitor. Unless other arrangements have been made all items are to be left in booth at end of show. Substitutions (same size, different plant) may be necessary due to availability and at the discretion of DWA. Prices include installation, rental and removal. Include Sales and/or Use Taxes as indicated. Make payment in U.S funds drawn on a U.S. bank. **Cancellation Policy:** Items cancelled will be charged at 25% of original price prior to move-in, 50% after move-in begins and 100% after installation.

Company Name		Booth Number		All orders are governed by DWA's Payment Policy and Limits of Liability and Responsibility.
Billing Address		City	State Zip Code	
Telephone		Fax	E-mail	
Authorized Contact Signature		Authorized Contact-Please Print	Date	

RETURN TO: DWA Trade Show & Exposition Services
 6700 NE 59th Place Portland, Oregon 97218
 Telephone: 503/228-6800 Fax: 503/595-1470
 E-mail: csr@dwa-tradeshow.com
 http://www.dwa-tradeshow.com

011109R

Total of Items Ordered	\$	
Add 00% Sales and/or Use Tax	\$	-0-
PAYMENT ENCLOSED		\$

**ENVIRONMENTALLY FRIENDLY
 TABLE TOP DISPLAY
 ORDER FORM**

KEEP ORIGINAL & SEND COPY TO DWA



Cost Effective • Professional Appearance • Environmentally Friendly

Display prices below are all based on print-ready artwork being provided to DWA. Please refer to the Graphic Files Submission Guidelines form for all file specifications and FTP upload procedures. If you would like DWA to design your display for you, graphic design labor charges will apply. Please contact our Customer Service Department at 503-228-6800 with any questions.

Quantity	Size	Advance	Standard	Total
	⁸⁰¹⁷ 24" x 60" Table Top Display	\$ 90.00	\$117.00	\$
	⁸⁰¹⁸ 32" x 72" Table Top Display	\$135.00	\$175.00	\$
	⁸⁰¹⁹ 36" x 84" Table Top Display	\$185.00	\$235.00	\$
	⁸⁰²⁰ Graphic Design Labor, per hour	\$ 75.00	\$ 95.00	\$
	⁸⁰¹⁵ Carrying Envelope made from nylon reinforced vinyl	\$ 45.00	\$ 60.00	\$

SIGN ORDER POLICY
 Table top displays cancelled or changed after work has been started will be charged at 100% of the original price. Orders received after Advance Price Deadline will be charged at Rush Charge prices.

Include Sales and/or Use Taxes as indicated. Make payment in U.S funds drawn on a U.S. bank.

Company Name		Booth Number		All orders are governed by DWA's Payment Policy and Limits of Liability and Responsibility.
Billing Address		City	State Zip Code	
Telephone		Fax	E-mail	
Authorized Contact Signature		Authorized Contact-Please Print	Date	

RETURN TO: DWA Trade Show & Exposition Services
 6700 NE 59th Place Portland, Oregon 97218
 Telephone: 503/228-6800 Fax: 503/595-1470
 E-mail: csr@dwa tradeshow.com
 http://www.dwa tradeshow.com

011109R

Total of Items Ordered	\$	
Add 00% Sales and/or Use Tax	\$	-0-
PAYMENT ENCLOSED	\$	

**ENVIRONMENTALLY FRIENDLY
 CARDBOARD KIOSK DISPLAY
 ORDER FORM**
 KEEP ORIGINAL & SEND COPY TO DWA

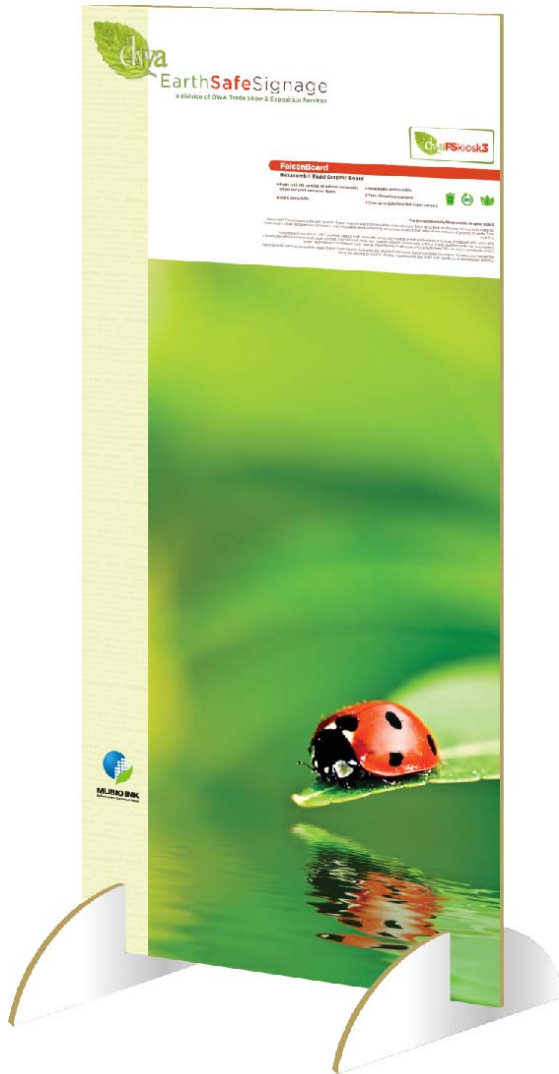

The Cardboard Kiosk Display is a 100% recyclable/biodegradable display and is durable enough for multiple uses. It is made entirely with FalconBoard, a rigid graphic board that prints vibrant graphics in a satiny finish.

FalconBoard is the only graphic display board made from reusable and 100% recyclable kraft paper honeycomb material. FalconBoard offers designers and printers a truly recyclable, environmentally-conscious product that helps divert millions of pounds of waste from landfills.



Display prices below are all based on print-ready artwork being provided to DWA. Please refer to the Graphic Files Submission Guidelines form for all file specifications and FTP upload procedures. If you would like DWA to design your display for you, graphic design labor charges will apply. Please contact our Customer Service Department at 503-228-6800 with any questions.

Quantity	Size	Advance	Standard	Total
8109	36" x 84" Kiosk Display w/feet	\$ 250.00	\$310.00	\$
8020	Graphic Design Labor, per hour	\$ 75.00	\$ 95.00	\$

SIGN ORDER POLICY
 Kiosk displays cancelled or changed after work has been started will be charged at 100% of the original price. Orders received after Advance Price Deadline will be charged at Rush Charge prices.

Include Sales and/or Use Taxes as indicated. Make payment in U.S funds drawn on a U.S. bank.

Company Name		Booth Number		
Billing Address		City	State	Zip Code
Telephone		Fax	E-mail	
Authorized Contact Signature		Authorized Contact-Please Print		Date

All orders are governed by DWA's Payment Policy and Limits of Liability and Responsibility.

RETURN TO: DWA Trade Show & Exposition Services
 6700 NE 59th Place Portland, Oregon 97218
 Telephone: 503/228-6800 Fax: 503/595-1470
 E-mail: csr@dwa tradeshow.com
 http://www.dwa tradeshow.com

011109R

Total of Items Ordered	\$	
Add 00% Sales and/or Use Tax	\$	-0-
PAYMENT ENCLOSED	\$	



**STANDARD SIGN & BANNER
 ORDER FORM**
 KEEP ORIGINAL & SEND COPY TO DWA

STANDARD SIGNS
 Signs are full-color digital graphics laminated and mounted to foamcore.

Quantity	Size	Advance	Standard	Total	
	8001 7" x 11"	\$ 30.00	\$ 45.00		SIGN ORDER POLICY Signs cancelled or changed after work has been started will be charged at 100% of the original price. Orders received after Advance Price Deadline will be charged at Standard prices.
	8002 7" x 44"	\$ 37.00	\$ 56.00		
	8003 11" x 14"	\$ 37.00	\$ 56.00		
	8004 14" x 22"	\$ 44.00	\$ 66.00		
	8005 22" x 28"	\$ 65.00	\$ 97.00		
	8008 24" x 36"	\$ 75.00	\$ 105.00		
	8006 28" x 44"	\$ 84.00	\$ 118.00		
	8007 40" x 60"	\$146.00	\$ 217.00		
	8009 3' x 8'	\$175.00	\$ 253.00		
	8010 4' x 8'	\$195.00	\$ 273.00		
	8011 Grommet, per piece	\$ 1.00	\$ 1.50		<input type="checkbox"/> Please indicate here if you would like us to call you and provide more information and pricing on banners, cut-out letters, logos, silk screening, special graphics, or any other items.
	8013 Easel Back, per piece	\$ 5.00	\$ 6.00		
	8021 Banner	Call for Quote	Call for Quote		
	8020 Designer Labor, per hour (for specific/custom design needs)	\$ 75.00	Call for Quote		

Choose sign orientation:
 (Check appropriate box)

 Horizontal

 Vertical

 Use Your Judgement for Sign Layout

Specify sign copy and indicate colors here. Please print clearly, if more space is needed attach a separate piece of paper.

In order to ensure that your graphic images come out at the highest quality, send EPS vector art whenever possible. Photo-based or bitmap art should be in TIFF format and should be at least 600 dpi at 1/8th size. All colors in files and links should be set up and specified as CMYK (no RGB or spot colors). Include all screen and printer fonts used in your artwork (true type fonts) or convert all text to curves. Always include a hard copy or PDF file of your artwork.

Company Name		Booth Number		All orders are governed by DWA's Payment Policy and Limits of Liability and Responsibility.
Billing Address		City	State Zip Code	
Telephone	Fax	E-mail		
Authorized Contact Signature	Authorized Contact-Please Print	Date		

RETURN TO: DWA Trade Show & Exposition Services
 6700 NE 59th Place Portland, Oregon 97218
 Telephone: 503/228-6800 Fax: 503/595-1470
 E-mail: csr@dwa tradeshow.com
 http://www.dwa tradeshow.com

Total Graphics Ordered	\$	
Add 00% Sales and/or Use Tax	\$	-0-
PAYMENT ENCLOSED	\$	

Any files that do not conform to the specifications described below will incur additional fees beyond the current pricing shown in our exhibitor kits. Print-ready PDF is the only acceptable file type without incurring graphic design charges. Any in-house work that is needed to modify files provided by client to a print ready state will be billed at \$65.00 per hour with a half-hour minimum. Any files that must be opened in their native application and exported to the required file types below do not conform to this specification.

FILE TYPES

Digital files (logos, photos, finished layouts, etc.) should be saved or exported from your design application to PDF, EPS or TIFF with a minimum resolution of 300 dpi at 50% OF THE FINAL PRODUCTION SIZE. The higher the resolution provided, the better the results. JPEG's are less desirable but can be accepted if the resolution is 300 dpi or higher. Company logos should always be sent in a vector-based format to ensure a crisp, clean logo print. Placed images are to be embedded rather than linked. If files are linked, be sure to send the linked sites.

PLEASE DO NOT submit GIF files, Word (.doc) files, Power Point (.ppt.) files, Publisher files, InDesign files or any file formatted for or taken from a website. Web graphics are not suited for large format printing. This is a very common error and should be avoided.

PAGE LAYOUT / IMAGE SIZE

Image should be cropped and scaled to intended print size or to a percentage of print size (no less than 25% for vector based, 50% for bitmap based). Remove non-printing borders. Final resolution should be NO LESS than 100 dpi at FINAL print size. Higher resolutions will produce superior results. Image should be flattened, no layers and/or transparent objects. Color halftone images should be submitted in CMYK color mode. If arrangements are made ahead of time with our Graphics Department, Native files can be sent if any changes or additions are anticipated but these should not be considered as the primary print files.

FONTS

All fonts should be converted to outlines or paths. Text should be converted to outlines to ensure kerning, leading and font size stay exactly as designed. Send font files if there is an anticipation of any changes or additions. Any in-house changes will be billed as described above.

PROOFING

A clean, hard copy proof and a PDF proof should be sent along with the print files for reference. Files provided without proofs will be printed as is without correction applied. Any re-prints necessary due to proofs not being provided are done at additional cost to the client.

BLEED

Graphics must include one-eighth inch of bleed for products mounted on the following substrates: Dibond, aluminum, plywood, sintra and acrylics.

COLOR MODE

Files may be submitted in CMYK or RGB. You may also include PMS colors in your graphics (Coated palettes only). Although PMS colors will be run as 4-color process, keep them as spot colors in your documents to ensure a more accurate match.

CRITICAL COLORS

All Pantone and critical call out values must be specified in writing to DWA at the time of submission. Please note that approximate matching of any one color requires additional time and resources, and an additional charge may apply. DWA cannot guarantee that the colors on your final print will match the colors produced by your monitor – monitors produce a greater range of color, brightness and saturation than any printer.

SENDING FILES

Files can be sent on CD-ROM or DVD (recommended for extremely large, high resolution files) or posted to your FTP site or any online file transmission site i.e., Dropbox. For information on our web based file transfer services, contact us at signs@dwa-tradeshows.com or at 503-595-1465. Smaller files (-10MB) can be emailed directly to signs@dwa-tradeshows.com.

LABOR SERVICES (Please indicate services desired)

DWA SUPERVISED (OK to proceed without exhibitor/display house supervision) Please check all that apply. Please complete information needed on page two of labor form.

Installation

Exhibits are set up prior to exhibitor's arrival under the direction of DWA supervisors.
 A 25% (\$30.00 minimum) surcharge will be added to the labor rates below for this supervision.

Dismantle

Exhibits are dismantled after show closing under the direction of DWA supervisors.
 A 25% (\$30.00 minimum) surcharge will be added to the labor rates below for this supervision.

EXHIBITOR SUPERVISED (Do not proceed without exhibitor/display house supervision) Exhibitor will supervise: (Please check all that apply)

Installation

Exhibitor will need ___ workers on (date) _____ at (time) _____ AM PM for (hours) _____

Dismantle

Exhibitor will need ___ workers on (date) _____ at (time) _____ AM PM for (hours) _____

Starting time can be guaranteed only in those instances where labor is requested for the start of the working day, which is 8:00 am. Check in at the DWA service desk to pick up your labor.

LABOR RATES

		ADVANCE	STANDARD
Straight Time	between 8:00 am and 4:30 pm weekdays	\$58.00 per hr	\$68.00 per hr
Overtime	before 8:00 am and after 4:30 pm weekdays and all day Saturdays and Sundays	\$87.00 per hr	\$107.00 per hr

Please estimate the number of workers and hours per worker needed below. Invoices will be calculated according to actual hours worked. Labor canceled without 24 hour notice shall be charged a one (1) hour cancellation fee per worker.

	No. of workers	x	Hours per worker	=	Total worker hours	at Rate	Total
Installation						\$ _____ /hr.	\$
Dismantle						\$ _____ /hr.	\$

The minimum charge for labor is one (1) hour per worker. After one hour, labor is charged in one-half (1/2) hour increments. Gratuities in any form, including cash and gifts are prohibited.

Company Name		Booth Number		All orders are governed by DWA's Payment Policy and Limits of Liability and Responsibility.
Billing Address		City	State Zip Code	
Telephone	Fax	E-mail		
Authorized Contact Signature		Authorized Contact-Please Print	Date	

RETURN TO: DWA Trade Show & Exposition Services
 6700 NE 59th Place Portland, Oregon 97218
 Telephone: 503/228-6800 Fax: 503/595-1470
 E-mail: csr@dwa-tradeshow.com
 http://www.dwa-tradeshow.com

Estimated Labor Services Ordered	\$
Add 25% (\$30 min.) for Install Supervision	\$
Add 25% (\$30 min.) for Dismantle Supervision	\$
PAYMENT ENCLOSED	\$

(SEE PAGE TWO)



INBOUND FREIGHT INFORMATION

CARRIER _____ SHIPPED BY _____ DATE _____
NUMBER OF PIECES _____ WEIGHT _____ PRO NUMBER _____
ARRIVAL DATE _____ SHIPPED TO: WAREHOUSE SHOWSITE

SET UP INFORMATION FOR DWA INSTALLATION

SET UP DRAWINGS ATTACHED RENTAL CARPET COLOR
 SET UP DRAWINGS WITH EXHIBIT OWN CARPET COLOR
CASE/CRATE NUMBER _____ PADDING
NUMBER OF WORKERS REQUIRED FOR SET-UP _____ APPROXIMATE TIME FOR SET-UP _____
 FORKLIFT ORDERED HRS _____ TIME _____ SPECIAL EQUIPMENT REQUIRED _____

DID YOU ORDER

ELECTRICAL YES NO ELECTRICAL UNDER CARPET YES NO
ELECTRICAL DRAWINGS ATTACHED SENT TO THE OFFICIAL ELECTRICAL CONTRACTOR W/EXHIBIT

OUTBOUND FREIGHT INFORMATION

IMPORTANT: You must make arrangements for outbound shipping and contact the carrier of your choice.

OUTBOUND FREIGHT CHARGES PREPAID COLLECT BILL TO _____
CONSIGNEE TO _____
ADDRESS _____
CITY _____ STATE _____ ZIP _____
SECOND CONSIGNEE _____
ADDRESS _____
CITY _____ STATE _____ ZIP _____
 DWA STORAGE
METHOD SHOWCARRIER AIR FREIGHT VANLINE OTHER _____
CARRIER (IF KNOWN) _____
CONTACT _____ PHONE _____

EMERGENCY CONTACT INFORMATION / SHOWSITE CONTACT

NAME _____ TITLE _____
TELEPHONE _____
OTHER MEANS OF CONTACTING THIS PERSON _____
CONTACT'S HOTEL _____ ARRIVAL _____ DEPARTURE _____
PURCHASING AUTHORIZATION YES NO



We get your show on the *Road* or in the *Air*

YRC Freight is the Show's Recommended Carrier

Let YRC Freight assist in handling your **Ground, Air** and **Expedited** shipping needs. Just stop by the Exhibitor's Service Desk and speak with our Trade Show Specialist from YRC Freight

YRC Freight's Services Advantages:

Time Critical - Any Need, Any Speed, Guaranteed.

- By Noon, By 5pm, Hour Window
- Guaranteed, By Noon, By 5 pm, Multiday Window

Standard Ground – The most reliable standard ground service in the Exhibit industry

Caravan Service – Conveniently transports your exhibit materials from show to show

Any Size Shipment – We have the ability to move everything from small packages to full truckloads at competitive prices

Sealed Exhibit – Is a safe, secure, guaranteed option to move your shipments and you only pay for the space you need.

World Class Customer Service – Our Exhibit customer service offers 24/7 support for your exhibit shipping needs at 1-800-531-EXPO (3976)

Don't worry if you are a first time user with YRC Freight, because we can establish competitive pricing for your outbound shipment right on the spot!

Contact us at 1- 800-531-EXPO (3976), yrcfreight.com or exhibit.services@yrcfreight.com



**SHIPPING INSTRUCTIONS/
MATERIAL HANDLING INFORMATION**

DWA Trade Show & Exposition Services is prepared to receive your shipment either in advance at our local warehouse or at the exhibit site. See below for services covered by DWA. You may ship via YRC FREIGHT or the carrier of your choice.

For charges associated with these services, please refer to the Material Handling Order Form. Rates are based on the incoming weight of the shipments. DWA must have payment before forwarding freight.

For uncrating, unskidding, positioning, and reskidding equipment, please refer to the In-Booth Forklift Order Form. If your material requires specialized rigging equipment, please notify us promptly so that we can make arrangements. When possible, supply your own rigging equipment with shipments and pre-rig your equipment.

ADVANCE SHIPMENTS TO DWA WAREHOUSE *CRATES, CARTONS, FIBER CASES ONLY*

- Rates Include:
- ✓ Unloading crated freight. The warehouse cannot receive uncrated shipments.
 - ✓ Storing at the warehouse for up to 30 days.
 - ✓ Reloading onto trucks and delivery to the exhibit site.
 - ✓ Unloading freight and delivery to your booth.
 - ✓ Picking up, storing and returning empty shipping containers.
 - ✓ Reloading freight for return to your specified destination.

Make out the bill of lading and consign as follows:

NAME OF EVENT
YOUR COMPANY NAME
YOUR BOOTH NUMBER
C/O DWA Trade Show & Exposition Services
6700 NE 59th Place
Portland, Oregon 97218

IMPORTANT!
Last day for shipments to arrive at the advance warehouse without surcharge is **September 13, 2019**
The warehouse will receive shipments Monday through Friday during the hours of 8:00am to 4:00pm.

DIRECT SHIPMENTS TO EXHIBIT SITE

- Rates Include:
- ✓ Unloading freight and delivery to your booth.
 - ✓ Picking up, storing and returning empty shipping containers.
 - ✓ Reloading freight for return to your specified destination.

Make out the bill of lading and consign as follows:

NAME OF EVENT
YOUR COMPANY NAME
YOUR BOOTH NUMBER
C/O DWA Trade Show & Exposition Services
Facility Name
Facility Street Address
Facility City, State, Zip

IMPORTANT!
First day for shipments to arrive at the exhibit site is **September 18, 2019**

OUTGOING SHIPMENTS

Shipping information, bills of lading and labels will be available at the DWA Service Desk. Exhibitors selecting nonofficial carriers will need to make their own arrangements for pickup.

RETURN TO WAREHOUSE (Optional)

- After the show, DWA can:
- ✓ Deliver freight to the warehouse.
 - ✓ Store freight.

Call the DWA Customer Service Department at 503/228-6800 or stop in during the show at the DWA Service Desk for assistance.

Please read the DWA "Limits of Liability and Responsibility" for important information on freight handling.



MATERIAL HANDLING ORDER FORM
 KEEP ORIGINAL & SEND COPY TO DWA

ARRIVAL DATES FOR SHIPMENTS - PLEASE SCHEDULE SHIPPING CAREFULLY TO MINIMIZE SURCHARGES!

ADVANCE: September 13, 2019

Last day for crated shipments to arrive at advance warehouse without surcharge. A 25% (\$31.00 minimum) late arrival surcharge based on the below rates will apply to each shipment received at the warehouse after this date.

SHOW SITE: September 18, 2019

First day for shipments to arrive at exhibit site.

MATERIAL HANDLING RATES

Rates are round-trip, per shipment. Use incoming weight only and round up to the next 100 lbs. Rates below are guaranteed if inbound shipments are received at the DWA warehouse or exhibit site before 4:00 PM weekdays. **Late shipments to warehouse are subject to surcharges.** Certified Weight Tickets are required for each shipment.

ADVANCE SHIPMENTS TO WAREHOUSE

Advance shipments are shipments that can be received at the warehouse up to 30 days prior to the event, delivered to the exhibit site and can be unloaded at the dock and delivered to the booth with no additional handling required. Empty containers will be returned at the close of the show. When packed, the crated materials will be picked up at the booth and loaded onto outbound carriers. Late arrival charges additional, see above for details.

	SHIPMENT WEIGHT X	RATE/100 LBS.	MIN.CHARGE	ESTIMATED CHARGES
Crated and/or Skidded Materials	lbs.	⁶⁰⁰¹ \$58.00	⁶⁰⁰⁰ \$116.00	\$

DIRECT SHIPMENTS TO EXHIBIT SITE

Direct shipments are consigned to DWA, shipped directly to the event facility and can be unloaded at the dock and delivered to the booth with no additional handling required. Empty containers will be returned at the close of the show. When packed, the crated materials will be picked up at the booth and loaded onto outbound carriers.

	SHIPMENT WEIGHT X	RATE/100 LBS.	MIN.CHARGE	ESTIMATED CHARGES
Crated and/or Skidded Materials	lbs.	⁶⁰¹¹ \$52.00	⁶⁰¹⁰ \$104.00	\$

UNCRATED SHIPMENTS

Includes shipments that are not in crates, cases, or boxes and/or are unskidded without proper lifting bars or hooks. Empty containers will be returned at the close of the show.

	SHIPMENT WEIGHT X	RATE/100 LBS.	MIN.CHARGE	ESTIMATED CHARGES
Uncrated and/or Unskidded-Advance	lbs.	⁶⁰¹³ \$82.00	⁶⁰¹² \$164.00	\$
Uncrated and/or Unskidded-Exhibit Site	lbs.	⁶⁰¹³ \$79.00	⁶⁰¹² \$150.00	\$

CRATED SHIPMENTS REQUIRING SPECIAL HANDLING

Includes shipments that are loaded and/or packed in such a manner as to require additional handling such as ground loading, side door loading, constricted space loading, designated piece loading, or stacked shipments. Late arrival charges additional, see above for details.

	SHIPMENT WEIGHT X	RATE/100 LBS.	MIN.CHARGE	ESTIMATED CHARGES
To Warehouse	lbs.	⁶⁰⁴¹ \$79.00	⁶⁰⁴⁰ \$158.00	\$
To Exhibit Site	lbs.	⁶⁰⁴³ \$75.00	⁶⁰⁴² \$150.00	\$

SMALL PACKAGE SHIPMENTS

Round trip rates, per shipment. Limited to 50 lbs. per shipment, per delivery. Cartons and envelopes received without documentation will be delivered without guarantee of piece count or condition. Includes FedEx and UPS shipments. Late arrival charges additional, see above for details.

	NO. OF CARTONS	FIRST CARTON	EACH ADD'L. CARTON	ESTIMATED CHARGES
Small Packages/Max. 50 lbs. per shipment		⁶⁰³⁰ \$34.00	⁶⁰³¹ \$9.00	\$

If your freight remains at the Exhibit Site at the end of the show, there will be a charge of \$12.50 per cwt with a minimum fee of \$125.00 for DWA to return your freight to its warehouse. In addition, there may be a fee for storage. It is the exhibitor's responsibility to arrange for freight pickup from DWA's warehouse.

Company Name		Booth Number		All orders are governed by DWA's Payment Policy and Limits of Liability and Responsibility.
Billing Address		City	State Zip Code	
Telephone		Fax	E-mail	
Authorized Contact Signature		Authorized Contact-Please Print	Date	

RETURN TO: DWA Trade Show & Exposition Services
 6700 NE 59th Place Portland, Oregon 97218
 Telephone: 503/228-6800 Fax: 503/595-1470
 E-mail: csr@dwatradeshow.com
 http://www.dwatradeshow.com

Total Estimated Charges	\$
PAYMENT ENCLOSED	\$

Invoicing will be done from the actual weight, not the above estimates.

PLEASE CHECK YOUR SELECTION

\$1075.00 #1

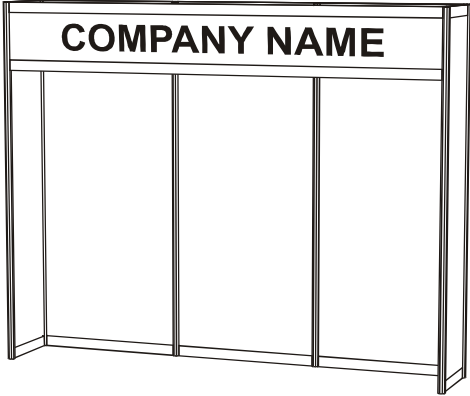

Modular Display System #1 - 10' Backwall
 One White Header with Black Copy

\$1,450.00 #2

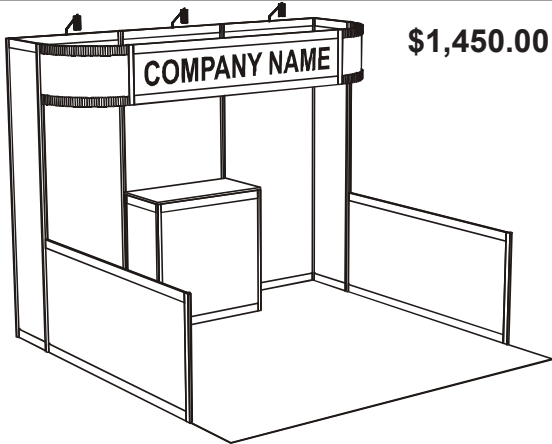

Modular Display System #2 - 10' x 10'
 One White Header with Black Copy
 One 1 Meter Counter with Sliding Doors
 Three Arm Lights
 Standard Booth Carpet

#3 \$2,900.00

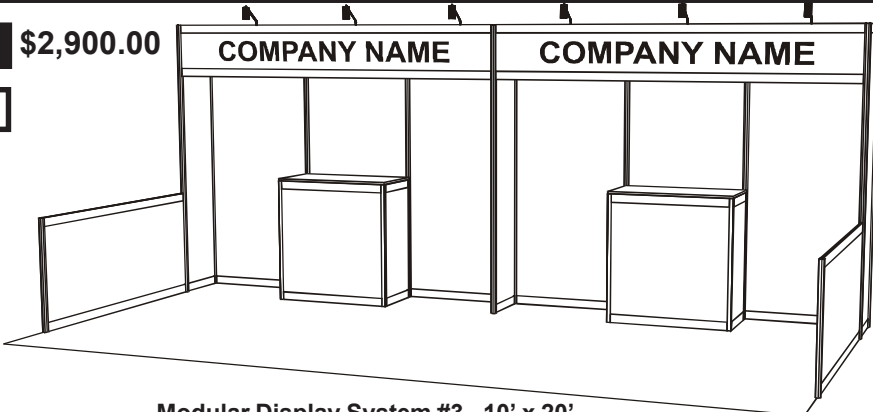

Modular Display System #3 - 10' x 20'
 Two White headers with Black Copy
 Two 1 Meter Counters with Sliding Doors
 Six Arm Lights
 Standard Booth Carpet

PLEASE FILL OUT ORDER FORM ON PAGE TWO.

\$3,500.00 #4

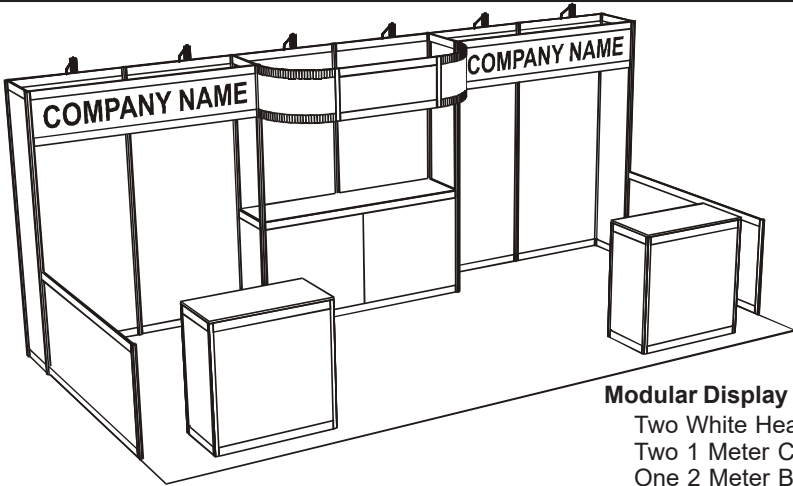

Modular Display System #4 - 10' x 20'
 Two White Headers with Black Copy
 Two 1 Meter Counters with Sliding Doors
 One 2 Meter Built-In Counter with Sliding Doors
 Six Arm Lights
 Standard Booth Carpet



Modular Display Systems Include - Installation and dismantling labor - Standard header copy (black)	PLEASE SELECT ONE TYPE OF BACKGROUND PANEL COLOR: Fabric: <input type="checkbox"/> Grey <input type="checkbox"/> Black <input type="checkbox"/> Blue Hardwall: <input type="checkbox"/> White <input type="checkbox"/> Black <input type="checkbox"/> Blue
--	---

PLEASE SELECT CARPET COLOR CHOICE: (For Modular Display Systems #2, #3, and #4 Only)

Grey
 Blue
 Red
 Teal
 Black
 Forest Green
 Plum

INDICATE YOUR HEADER COPY:

INDICATE SECOND HEADER COPY: (For Modular Display Systems #3 & #4 Only)

ACCESSORIES					
	<u>Quantity</u>	<u>Advance</u>	<u>Standard</u>		
Arm Lights	_____	\$ 38.00	\$ 46.00		
Literature Pockets	_____ Letter	\$ 15.00	\$ 15.00		
Light Boxes	_____ Small	\$200.00	N/A		
	_____ Medium	\$250.00	N/A		
	_____ Large	\$325.00	N/A		
Counters	_____ 1 Meter	\$200.00	\$275.00		
	_____ 2 Meter	\$250.00	\$325.00		
	_____ Curved	\$250.00	\$325.00		
Shelves (40" x 12")	_____ Straight	\$ 30.00	\$ 40.00		
	_____ Angle	\$ 38.00	\$ 48.00		
Wirewall Panels	_____ Black	\$225.00	N/A		

QUICK TIPS FOR EASY EXHIBITING

- * Consider ordering floral accessories to enhance your exhibit on the Plant Order Form enclosed.
- * If you are shipping literature or products, please refer to the Material Handling Order Form to arrange for delivery of those items to your exhibit.
- * If you have any questions or need assistance in completing your order, please call us and ask for the Customer Service Department.
- * Remember to order in advance to save time and money. Orders received after the Deadline Date or without payment will cost you up to an additional 30% over prices indicated and are subject to availability.

Please note: Furniture, vacuum service and electricity are not included in above price. Header copy will be black. For special lettering and/or logo work, please call for a quote.

Cancellation Policy: Items cancelled after move-in begins will be charged 100%. Any custom display panels or graphics cancelled after start of construction will be charged 100%.

ALLOW TWO WEEKS FOR ORDER PROCESSING AND UNIT PREPARATION. CALL FOR AVAILABILITY AND PRICING AFTER TWO WEEKS

Company Name	Booth Number	All orders are governed by DWA's Payment Policy and Limits of Liability and Responsibility.
Billing Address	City State Zip Code	
Telephone	Fax E-mail	
Authorized Contact Signature	Authorized Contact-Please Print Date	

RETURN TO: DWA Trade Show & Exposition Services
 6700 NE 59th Place Portland, Oregon 97218
 Telephone: 503/228-6800 Fax: 503/595-1470
 E-mail: csr@dwa tradeshow.com
 http://www.dwa tradeshow.com

MDS # _____	\$
Additional Items	\$
PAYMENT ENCLOSED	\$

PLEASE CHECK YOUR SELECTIONS

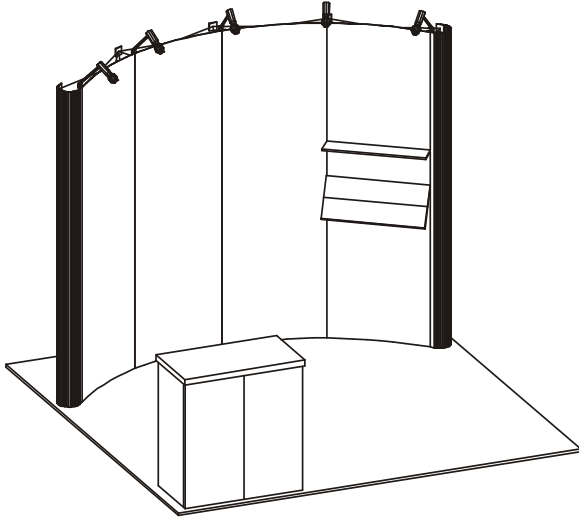

**EXPOSURE POP-UP DISPLAY
 FEATURES**

- 10' Exhibit
- Shelves
- Spotlights
- Free standing Counter with Shelf

Colors Available: Black Silver

- \$936.00 Full Package (as shown)
- \$675.00 Without Counter

**EXPOSÉ PANEL DISPLAY
 FEATURES**

- 10' Exhibit
- Header with Black Copy
- Two Spotlights
- Free standing Counter with Shelf

Colors Available: Black Silver

- \$1,023.00 Full Package (as shown)
- \$725.00 Without Counter

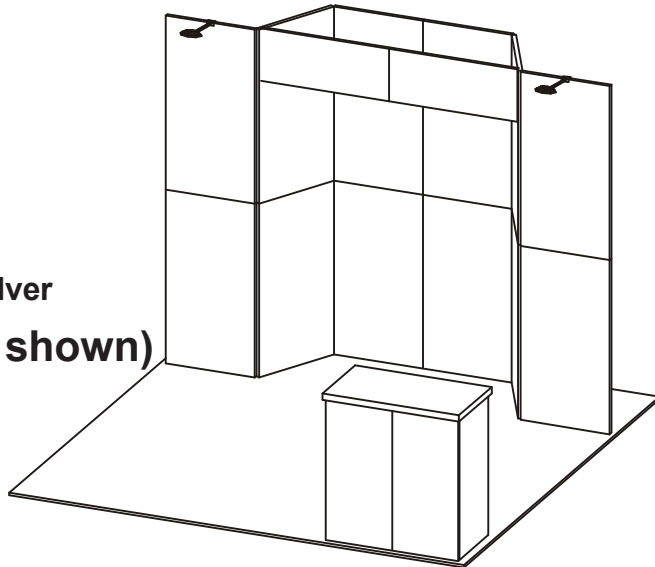

GRAPHICS

- Headers
- Logo reproduction
- Text graphics
- Photos / murals **Call for quote**

Header Copy:

Prices include installation, rental and removal. Include Sales and/or Use Taxes as indicated. Make payment in U.S funds drawn on a U.S. bank.
Cancellation Policy: Items cancelled will be charged 100% of original price after move-in begins.

Company Name	Booth Number	All orders are governed by DWA's Payment Policy and Limits of Liability and Responsibility.
Billing Address	City State Zip Code	
Telephone	Fax PO#	
Authorized Contact Signature	Authorized Contact-Please Print Date	

RETURN TO: DWA Trade Show & Exposition Services
 6700 NE 59th Place Portland, Oregon 97218
 Telephone: 503/228-6800 Fax: 503/595-1470
 E-mail: csr@dwa-tradeshow.com
 http://www.dwa-tradeshow.com

Total Displays/Graphics Ordered	\$	
Add 00% Sales and/or Use Tax	\$	-0-
PAYMENT ENCLOSED	\$	

CURVED TABLE TOP RENTAL DISPLAY ORDER FORM
 KEEP ORIGINAL & SEND COPY TO DWA

PLEASE CHECK YOUR SELECTION

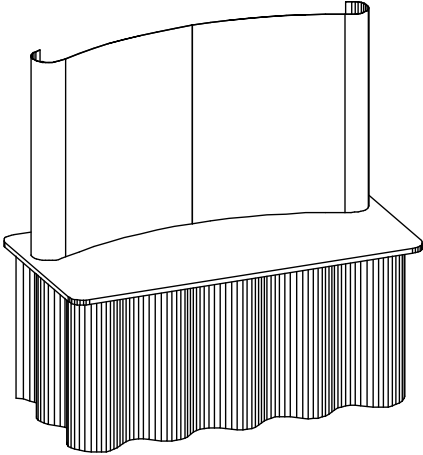
<input type="checkbox"/> 6' Table-Top Display* 	<table border="0" style="width: 100%;"> <tr> <td style="text-align: center;"><u>Advance</u></td> <td style="text-align: center;"><u>Standard</u></td> </tr> <tr> <td style="text-align: center;">\$298.00</td> <td style="text-align: center;">\$357.00</td> </tr> </table> <p>FEATURES Two Front Fabric Panels Color: Black Two Curved Fabric End Panels</p>	<u>Advance</u>	<u>Standard</u>	\$298.00	\$357.00	<div style="border: 1px solid black; padding: 5px;"> <p><u>Suggested Accessories</u> One Halogen Light Package - \$35.00 Three Standard Light Package - \$85.00</p> </div>
<u>Advance</u>	<u>Standard</u>					
\$298.00	\$357.00					

*Table is not included.

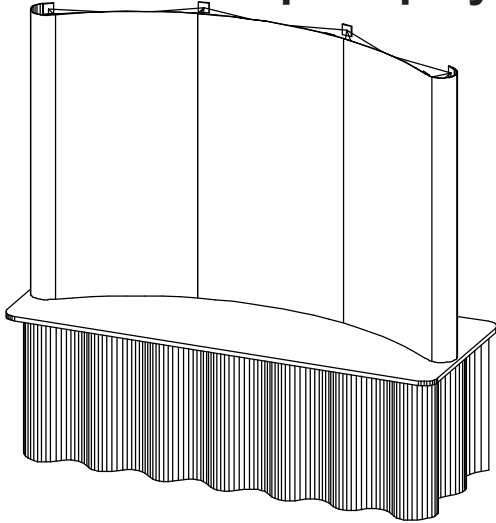
<table border="0" style="width: 100%;"> <tr> <td style="text-align: center;"><u>Advance</u></td> <td style="text-align: center;"><u>Standard</u></td> </tr> <tr> <td style="text-align: center;">\$350.00</td> <td style="text-align: center;">\$435.00</td> </tr> </table> <p>FEATURES Three Front Fabric Panels Color: Black Two Curved Fabric End Panels</p>	<u>Advance</u>	<u>Standard</u>	\$350.00	\$435.00	<input type="checkbox"/> 8' Table-Top Display* 	<div style="border: 1px solid black; padding: 5px;"> <p><u>Suggested Accessories</u> Two Halogen Light Package - \$70.00 Four Standard Light Package - \$105.00 Basic Shelf Package - Slant Literature - Black - \$49.00 - Straight Literature - Black - \$49.00</p> </div>
<u>Advance</u>	<u>Standard</u>					
\$350.00	\$435.00					

*Table is not included.

Prices include installation, rental and removal. Include Sales and/or Use Taxes as indicated. Make payment in U.S. funds drawn on a U.S. bank.
Cancellation Policy: Items cancelled will be charged 100% of original price after move-in begins.

Company Name	Booth Number	All orders are governed by DWA's Payment Policy and Limits of Liability and Responsibility.
Billing Address	City State Zip Code	
Telephone	Fax PO#	
Authorized Contact Signature	Authorized Contact-Please Print Date	

RETURN TO: DWA Trade Show & Exposition Services
 6700 NE 59th Place Portland, Oregon 97218
 Telephone: 503/228-6800 Fax: 503/595-1470
 E-mail: csr@dwa-tradeshow.com
 http://www.dwa-tradeshow.com

Total Displays/Graphics Ordered	\$	
Add 00% Sales and/or Use Tax	\$	-0-
PAYMENT ENCLOSED		\$

PLEASE CHECK YOUR SELECTIONS

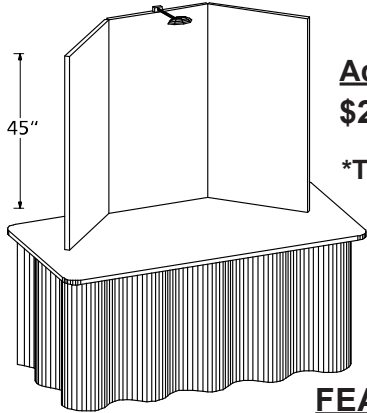
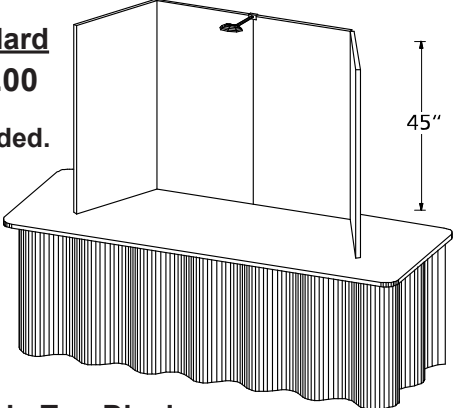
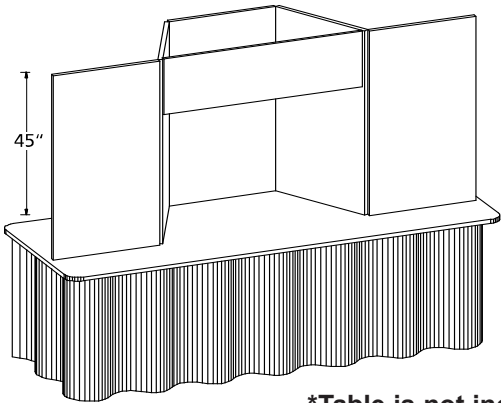
<div style="border: 1px solid black; padding: 5px; margin-bottom: 10px;"> <input type="checkbox"/> 4' Table-Top Display* </div>  <table style="margin-left: auto; margin-right: auto;"> <tr> <td style="text-align: center;"><u>Advance</u></td> <td style="text-align: center;"><u>Standard</u></td> </tr> <tr> <td style="text-align: center;">\$225.00</td> <td style="text-align: center;">\$265.00</td> </tr> </table> <p style="text-align: center;">*Table is not included.</p> <p style="text-align: center;">FEATURES</p> <p style="text-align: center;">Three Panel Table-Top Display One Halogen Spotlight Colors: <input type="checkbox"/> Black <input type="checkbox"/> Silver</p> <div style="border: 1px solid black; padding: 5px; margin-top: 10px;"> <p>Suggested Accessories Halogen Spotlights - \$35.00 Each Header Graphic (Call for Quote)</p> </div>	<u>Advance</u>	<u>Standard</u>	\$225.00	\$265.00	<div style="border: 1px solid black; padding: 5px; margin-bottom: 10px;"> <input type="checkbox"/> 6' Table-Top Display* </div>  <table style="margin-left: auto; margin-right: auto;"> <tr> <td style="text-align: center;"><u>Advance</u></td> <td style="text-align: center;"><u>Standard</u></td> </tr> <tr> <td style="text-align: center;">\$265.00</td> <td style="text-align: center;">\$315.00</td> </tr> </table> <p style="text-align: center;">*Table is not included.</p> <p style="text-align: center;">FEATURES</p> <p style="text-align: center;">Four Panel Table-Top Display One Halogen Spotlight Colors: <input type="checkbox"/> Black <input type="checkbox"/> Silver</p> <div style="border: 1px solid black; padding: 5px; margin-top: 10px;"> <p>Suggested Accessories Halogen Spotlights - \$35.00 Each Header Graphic (Call for Quote)</p> </div>	<u>Advance</u>	<u>Standard</u>	\$265.00	\$315.00
<u>Advance</u>	<u>Standard</u>								
\$225.00	\$265.00								
<u>Advance</u>	<u>Standard</u>								
\$265.00	\$315.00								
<div style="border: 1px solid black; padding: 5px; margin-bottom: 10px;"> <input type="checkbox"/> 8' Table-Top Display* </div>  <table style="margin-left: auto; margin-right: auto;"> <tr> <td style="text-align: center;"><u>Advance</u></td> <td style="text-align: center;"><u>Standard</u></td> </tr> <tr> <td style="text-align: center;">\$325.00</td> <td style="text-align: center;">\$395.00</td> </tr> </table> <p style="text-align: center;">*Table is not included.</p> <p style="text-align: center;">FEATURES</p> <p style="text-align: center;">Five Panel Table-Top Display One Header with Black Copy Colors: <input type="checkbox"/> Black <input type="checkbox"/> Silver</p> <p style="text-align: center;">Header Copy: <input style="width: 100%;" type="text"/></p> <div style="border: 1px solid black; padding: 5px; margin-top: 10px; text-align: center;"> <p>Suggested Accessories Halogen Spotlight Package - \$70.00</p> </div>		<u>Advance</u>	<u>Standard</u>	\$325.00	\$395.00				
<u>Advance</u>	<u>Standard</u>								
\$325.00	\$395.00								

Prices include installation, rental and removal. Include Sales and/or Use Taxes as indicated. Make payment in U.S. funds drawn on a U.S. bank.
Cancellation Policy: Items cancelled will be charged 100% of original price after move-in begins.

Company Name	Booth Number	All orders are governed by DWA's Payment Policy and Limits of Liability and Responsibility.
Billing Address	City State Zip Code	
Telephone	Fax PO#	
Authorized Contact Signature	Authorized Contact-Please Print Date	

RETURN TO: DWA Trade Show & Exposition Services
 6700 NE 59th Place Portland, Oregon 97218
 Telephone: 503/228-6800 Fax: 503/595-1470
 E-mail: csr@dwa-tradeshow.com
 http://www.dwa-tradeshow.com

Total Displays/Graphics Ordered	\$	
Add 00% Sales and/or Use Tax	\$	-0-
PAYMENT ENCLOSED	\$	

FIRE MARSHAL'S RULES

1. All decorative materials must be flame proofed or of a type acceptable to the Fire Marshal's Office. Use of bark dust, mulch, chips or hay, etc., is not allowed unless pre-approved by the Fire Marshal's office.
2. No flammable gasses, liquids or solids, are allowed in any building, enclosed tent or structure. Two (2) 16.4 oz. bottles of propane are permitted in a booth at any one time. All other bottles must be stored outside the building and secured.
3. **Tents, canopies and covers over booths are allowed inside building only at Oregon Convention Center, Exposition Center, Memorial Coliseum Arena and Rose Garden Arena where ceiling height is adequate.** Booths with canopies larger than 10' x 10' are not allowed unless approved by the Fire Marshal's Office. All canopied booths must have a working smoke detector properly mounted in the canopy. If cooking in a canopied booth, you must also have a fire extinguisher.
4. Any enclosed structure larger than 100 sq. ft. in floor area must have a working smoke detector properly mounted in the structure. All doors or windows to the structure are to be left open.
5. All natural gas lines used to run a fireplace etc. must have a shut off valve by the appliance(s) and be accessible. All persons working in the booth shall be instructed in the location and operation of the shut off valves to the appliances and to the building as well. All natural gas fireplace displays must have a safety pilot kit providing automatic shut off if no flame is detected. Each fireplace must additionally have a Carbon Monoxide detector with alarm and a protective barrier to safeguard against risk of being burned. No wood burning fireplaces are permitted.
6. Portable space heaters are not allowed unless approved by the Fire Marshal's Office.
7. Displaying of vehicles requires vehicles to have 1/4 tank or less of fuel in the tank; gas cap must be either locked or taped in place; and battery cables taped or batteries removed.
8. Displaying of any vehicle containing LPG gas propane shall have such containers reduced to atmospheric pressure before bringing them into the building.
9. All exhibitors are to keep all their exhibit items, tables, chairs, etc., within their assigned booth space. Nothing is to be placed in any aisle.
10. Empty cardboard boxes are not to be stored within booths overnight.
11. OBSTRUCTIONS BLOCKING UTILITY FLOOR BOXES MUST BE RELOCATED BY THE EXHIBITOR UPON REQUEST.

Oregon Convention Center Services

If you need to order any of the following services please visit the Oregon Convention Center's website at <http://www.oregoncc.org> or call them at 503.235.7578 or 800.791.2250.

- ✧ Electrical
- ✧ Compressed Air, Water, Drain & Natural Gas
- ✧ Booth Cleaning & Porter Service
- ✧ Audio Visual
- ✧ Telecommunication, Internet & Networking

SUSTAINABILITY GUIDELINES

for Exhibitors

EXHIBITOR AND DECORATOR GUIDE TO REDUCING WASTE

We strive to send as little material as possible to the landfill through recycling, composting and donating left over goods.

WHAT YOU CAN DO

1

REDUCE WASTE

- Use the facility recycling receptacles during move in/out and run of the show.
- Use only products that are recyclable at OCC.
- Minimize packaging.
- Bring only what is anticipated for attendees.
- Provide information on a reusable flash drive or through a QR code.

2

SMART EXHIBIT DISPLAY DESIGN

- Create signs and banners that are reusable or that can be recycled.
- Foam core is not allowed, as it cannot be recycled.
- Print handouts on post consumer recycled content paper using soy or vegetable based inks.
- Use energy efficient lighting for displays.
- Turn off booth lighting, monitors, and electronic equipment overnight.

3

TRANSPORTATION CONSIDERATIONS

- Use local vendors when possible to reduce transportation impact.
- Use local public transportation, walk or bike when possible. Visit the transit system website at trimet.org.
- Purchase offsets for the environmental footprint from shipping, travel and lodging. Ask us for resources.

RECYCLING RESULTS



Each year we recycle, compost, and donate over 500,000 pounds of material instead of putting it in a landfill.

SORTING GUIDE

You may sort and recycle your event material into the following category containers:

- **Corrugated Cardboard/Cardboard Tubes**
- **Film Plastic/Shrink Wrap/Bubble Wrap/Plastic Bags/Sheet Plastic** (*Must be clean and dry. No strapping, paper, or food scraps*)
- **Styrofoam Peanuts**
- **Vinyl Tablecloths** (*no banners*)
- **Lumber/Plywood/Particle Board/Scraps**
- **Scrap Metal**
- **Concrete/Brick/Porcelain/Pavers/Asphalt**
- **Plants/Trees/Soil/Mulch/Flowers**
- **Food Scraps** (*Includes meat, bones, dairy*)
- **Plastic Beverage Bottles/Soda Cans/Paper/Newspapers** (*Must Be Clean*)
- **Glass Bottles/Jars** (*Must Be Clean*)



Please consider your environmental responsibility before printing this document.